

STAIR & RAILING PRODUCTS BY



**HOUSE OF
FORGINGS**

Powder Coated & Stainless Steel

**House of Forgings
is the benchmark in
the stair and railing
industry, offering an
unsurpassed
selection of quality
products and
expert service.**

Our vast selection of products will meet the needs of even the most discerning customers. Whether selecting a powder coated finish or stainless steel, our newels, balusters and accessories will compliment a broad range of architectural styles.

STAIR & RAILING PRODUCTS BY



**HOUSE OF
FORGINGS**

Table of Contents

POWDER COATED & STAINLESS STEEL	2-49
Stainless Steel Cable Railing	2-5
Finishes & Patinas	6-7
Aalto	8-11
Tuscan	12-17
Orleans	18-19
Monte Carlo	20-21
Endecor	22-23
Designer	24-25
Stainless	26-27
Santa Fe	28-29
Gothic	30-31
Round	32-35
Versatile	36-39
Ribbon	40-43
Twist	44-47
Accessories	48-49
FORGED PANELS	50-71
Rebecca	51-53
Tuscany	54-57
Seville	58-59
Milano	60-62
Bordeaux	64-67
Regency	68-71
WOOD	72-83
Newels & Balusters	74-75
Elegante & Box Newels	76-77
Handrail & Fittings	78-79
Treads	80
Starter Steps	81
Lumber & Plywood	81
Moulding	82
Accessories	83
COMPANY & PRODUCT INFORMATION	84



Red Oak 4000 Newels, 6084 Handrail with stainless round bar bracket (shown)

Create the ideal modern aesthetic by combining stainless steel cable and rich oak. The expansive views allowed for by cable make it ideal for balconies as well as staircases.

— Stainless Steel —
Cable Railing

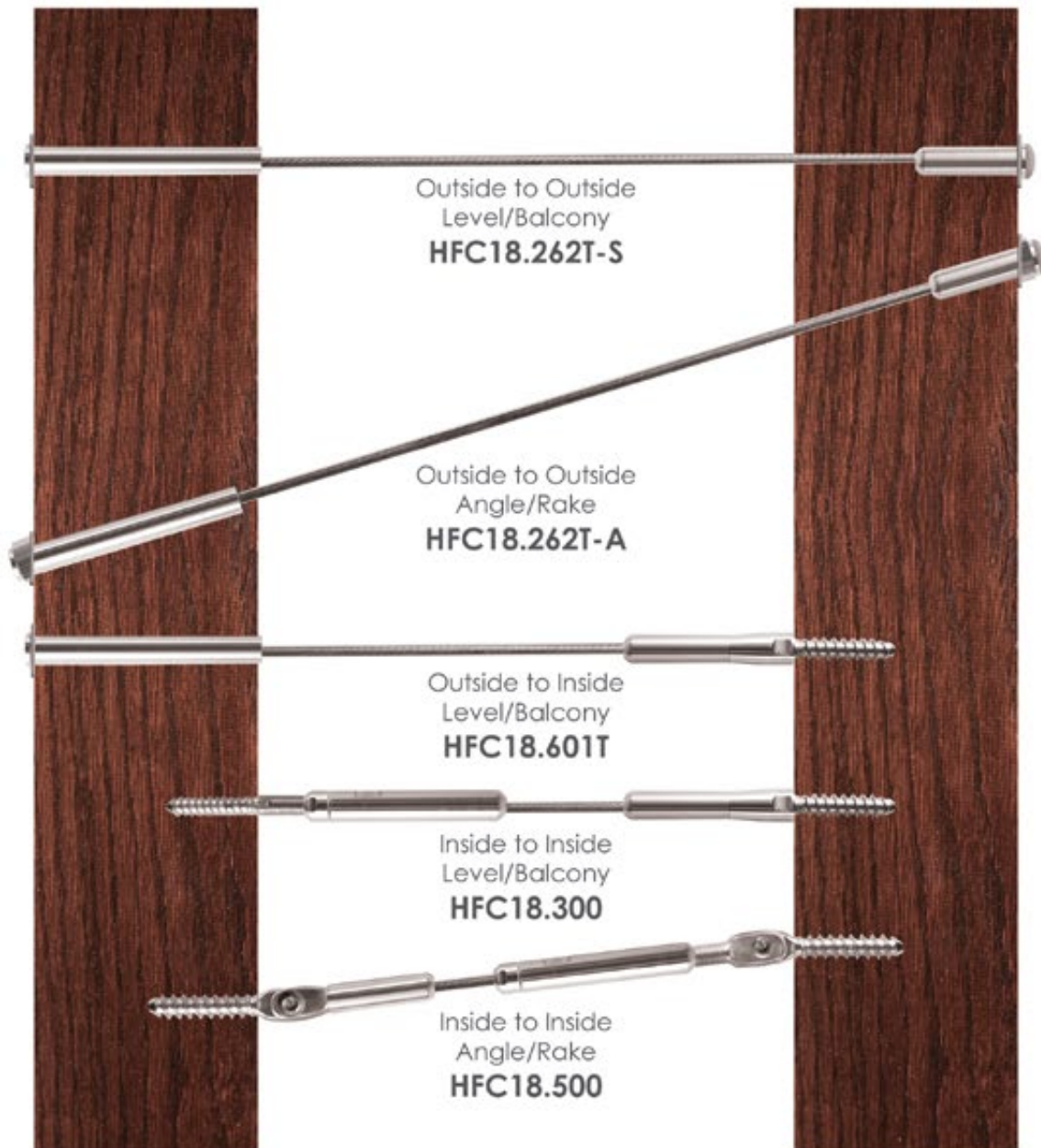

Outside to Outside
Level/Balcony
HFC18.262T-S



Outside to Outside
Angle/Rake
HFC18.262T-A



Outside to Inside
Level/Balcony
HFC18.601T



Pre Swaged 1/8" cable (5',10',15',18')

- HFC18-5T** (5ft) Swaged Threaded Stud
- HFC18-10T** (10ft) Swaged Threaded Stud
- HFC18-15T** (15ft) Swaged Threaded Stud
- HFC18-18T** (18ft) Swaged Threaded Stud

Inside to Inside
Level/Balcony
HFC18.300



Inside to Inside
Angle/Rake
HFC18.500

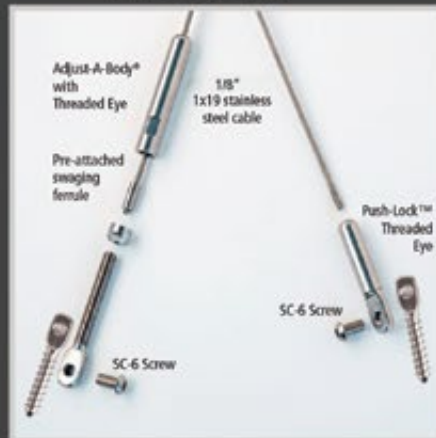

Pre Swaged 1/8" cable (5',10',15',18')

- HFC18-5** (5ft) Swaged Ferrule
- HFC18-10** (10ft) Swaged Ferrule
- HFC18-15** (15ft) Swaged Ferrule
- HFC18-18** (18ft) Swaged Ferrule

* All components are made from 316 Stainless Steel for marine grade corrosion resistance.

Modern Handrail



Modern Hand Rail
HT. 1-5/8"
W. 2-5/8"



**NEW PRODUCT
EXCLUSIVE**

6084 Straight Rail
Available in 8' & 16'
No fittings available



Modern Hand Rail
HT. 1-5/8"
W. 2-3/4"

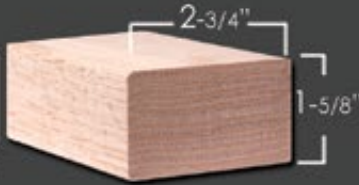

6002 Straight Rail
Available in 8' & 16'
No fittings available

Wall Mount Bracket

**NEW PRODUCT
EXCLUSIVE**



mounting hardware included

HF17.4002
HT. 2-1/2"
Base = 1-1/2" x 2"
Extends 3-1/4" off wall
ADJUSTABLE

Newel



4000
HT. 54"
W = 3-1/4"

Intermediate Newel



4923-41
HT. 41"
W = 1-3/4"



Stainless Newel (cut to length for brackets)

**NEW PRODUCT
EXCLUSIVE**



HF17.1.2-T
Ends: 1-3/16" Rd.
HT. 47"
Wt. 5.7 lbs.
TUBULAR

Newel Mount Bracket

**NEW PRODUCT
EXCLUSIVE**



mounting hardware included



HF17.4001
HT. 1-3/4"
Base = 1-1/2" sq.
ADJUSTABLE

Newel Cap

**NEW PRODUCT
EXCLUSIVE**



SQUARE CAP-4000
3-1/4" Square
3/4" x 1" dowel



Insert Tube



HFC18.TUBE

Release Key



HFC18.KEY

* All wood parts stocked in Red Oak

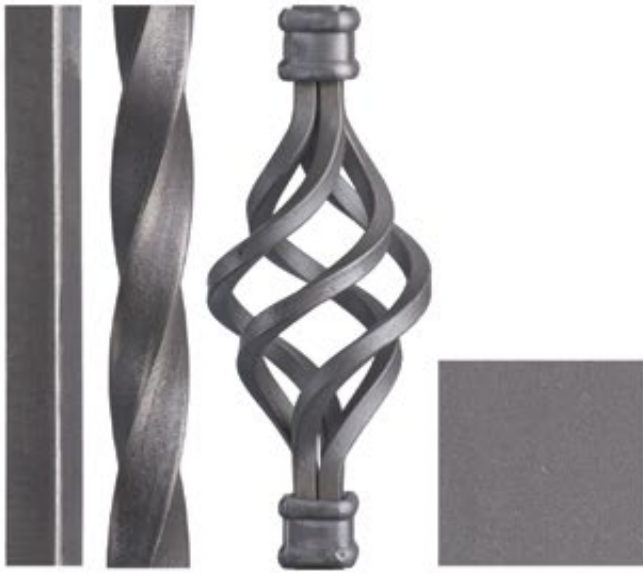

RAW IRON (RAW)

This is raw (unfinished) iron that needs to be painted or powder coated.



SATIN BLACK (STB)



ASH GREY (AG)



SILVER VEIN (SP)



COPPER VEIN (CV)



OIL RUBBED BRONZE (ORB)



OIL RUBBED COPPER (ORC)



ANTIQUÉ NICKEL (AN)



VINTAGE BRASS (VB)



SATIN CLEAR (SC)

This is a clear finish over RAW/unfinished iron, variations in surface color may occur.



STAINLESS STEEL

Finishes & Patinas

House of Forgings provides an unsurpassed selection of designs in the highest quality powdercoated finishes available. Our hand applied patinas enhance the lines and hammered detail of each unique piece. As interior design trends move forward, count on us to carry the latest styles & finishes.

THESE FINISHES HAVE BEEN PROFESSIONALLY PHOTOGRAPHED WITH THE HIGHEST INTEGRITY. OUR GOAL IS TO PRODUCE THE MOST REALISTIC MATCH TO THE ACTUAL FINISHES. HOWEVER SOME SLIGHT VARIANCES MAY OCCUR.

All images are the sole property of House of Forgings, LLC. and cannot be copied or reproduced without written permission.

AALTO



Ash Grey (shown)

Ash Grey (shown)

Our Aalto collection is a compliment to the modern design aesthetic. Adorn any space with the clean lines and open detail of these modern balusters and panels.



Satin Black (shown)



Satin Black (shown)



Satin Black (shown)



Ash Grey (shown)



Ash Grey (shown)

NEW PRODUCT
EXCLUSIVE

AALTO

SQUARE



Finishes & Patinas

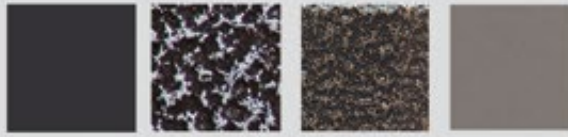

SATIN BLACK (STB) SILVER VEIN (SP) COPPER VEIN (CV) ASH GREY (AG)

	BALUSTERS	HF16.2.1	HF16.2.1-T	HF16.2.1-50	HF16.1.30	HF16.1.30-T	HF16.1.31	HF16.1.31-T	HF16.1.32	HF16.6.1	HF16.6.2	HF16.6.3	HF16.6.4	HF16.6.5	HF9.4.1	HF9.4.2	HF9.4.3	HF9.4.11	HF9.4.22	HF9.4.33
STB		•	•	•	•		•		•	•	•	•	•	•	•	•	•	•	•	•
SP		•	•		•		•		•											
CV		•	•		•		•		•											
AG			•			•		•		•	•	•	•	•	•	•	•	•	•	•

HF 16.2.1
Ends : 1/2" Sq.
Height: 44"
Wt. 3 lbs.
SOLID

HF 16.2.1-T
Ends : 1/2" Sq.
Height: 44"
Wt. 1.2 lbs.
TUBULAR

HF 16.2.1-50
Ends : 1/2" Sq.
Height: 50"
Wt. 3.2 lbs.
SOLID

HF 16.1.30
Ends : 1/2" Sq.
Height: 44"
Wt. 3.4 lbs.
SOLID

HF 16.1.30-T
Ends : 1/2" Sq.
Height: 44"
Wt. 1.6 lbs.
TUBULAR

HF 16.1.31
Ends : 1/2" Sq.
Height: 44"
Wt. 3.6 lbs.
SOLID

HF 16.1.31-T
Ends : 1/2" Sq.
Height: 44"
Wt. 1.75 lbs.
TUBULAR

HF 16.1.32
Ends : 1/2" Sq.
Height: 44"
Wt. 10 lbs.

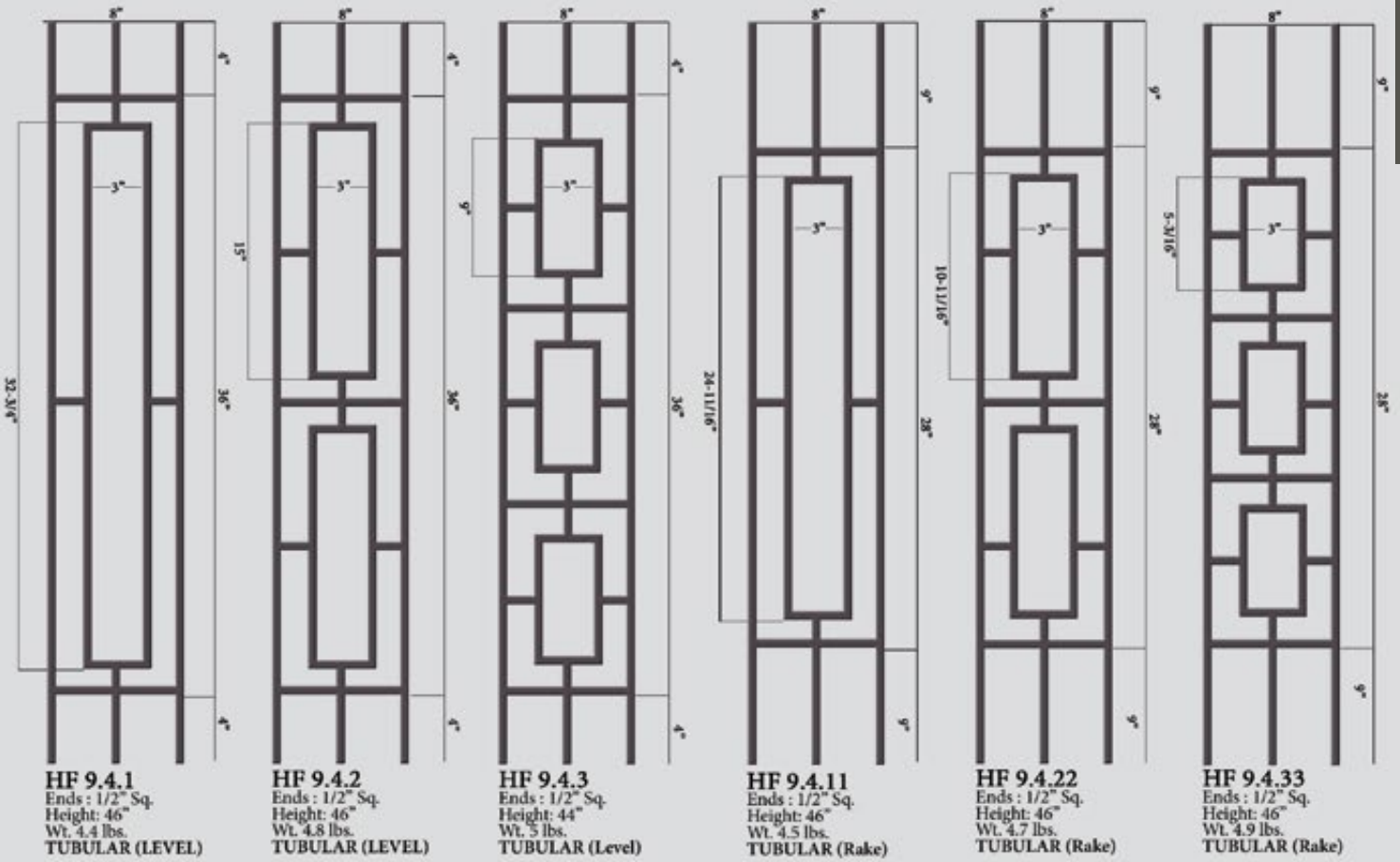

*Rake panels fit all angles up to 40 degrees

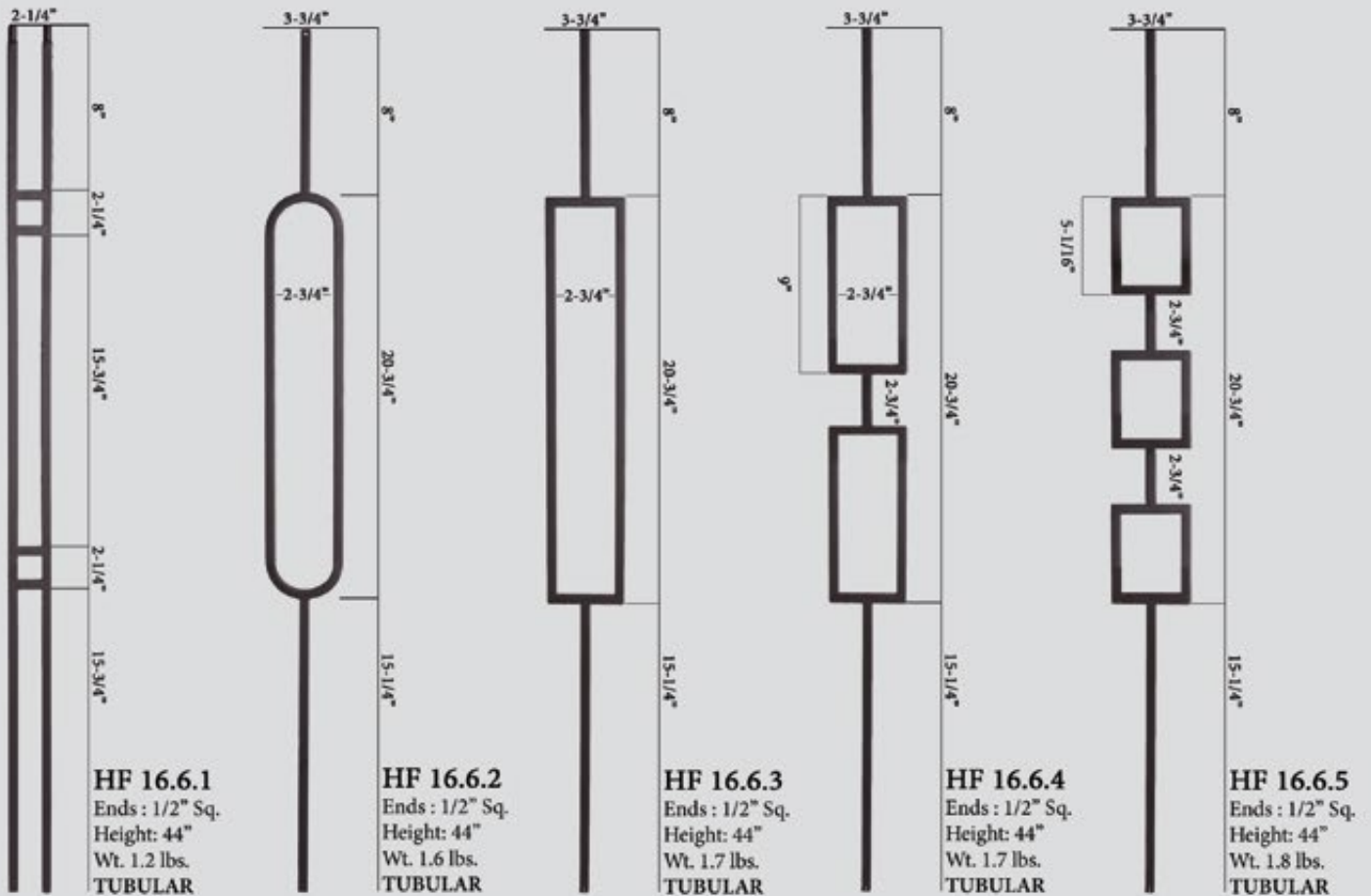



Oil Rubbed Bronze (shown)

The craftsmanship in these hand-forged balusters exude character and beauty nearly impossible to duplicate. Our Tuscan series is available in both round forged and square hammered profiles. Bring the rustic charm of old world Italy into your home with this unique series.

Oil Rubbed Bronze (shown)

TUSCAN



Vintage Brass (shown)



Oil Rubbed Bronze (shown)

TUSCAN

ROUND FORGED



Finishes & Patinas



	NEWELS	HF1.1.22	HF1.1.8	HF1.1.9	HF1.1.16	HF1.1.20	HF1.1.21	BALUSTERS	HF2.9.21	HF2.1.5	HF2.1.6	HF2.1.7	HF2.1.9	HF2.1.8	HF2.1.11	HF2.6.8	HF2.6.9	HF2.6.7	HF2.10.2	HF2.10.4	HF2.10.3	HF2.11.40	HF2.11.41
RAW	•			•	•				•				•	•	•	•	•	•	•	•	•		
STB		•	•	•	•	•	•		•	•	•	•	•	•	•	•	•	•	•	•	•	•	•
CV					•				•											•	•	•	
ORB		•	•	•	•	•	•		•	•	•	•	•	•	•	•	•	•	•	•	•	•	•
SC		•			•		•		•							•	•	•	•	•	•		
VB					•	•			•										•	•	•	•	•

ACCESSORIES

- Level base shoes
- Level base collars
- Angled base shoes
- Adjustable level base shoes
- Adjustable angled base shoes
- Newel mounting kit

- HF16.3.26
- HF16.3.40, HF16.3.43
- HF16.3.27
- HF16.3.44, HF16.3.46
- HF16.3.45, HF16.3.47
- HF16.3.33

- Photos: J.
- Photos: K. O.
- Photos: N.
- Photos: R.
- Photos: S.
- Photos: U.

For photos and full accessory details see pages 46-47





HF 2.1.9
 Ends : 9/16" Rd.
 Height: 44"
 Wt. 2.4 lbs.



HF 2.1.8
 Ends : 9/16" Rd.
 Height: 44"
 Wt. 4.2 lbs.



HF 2.1.11
 Ends : 9/16" Rd.
 Height: 44"
 Wt. 3 lbs.



HF 2.6.8
 Ends : 9/16" Rd.
 Tapered
 Height: 44"
 Wt. 3.2 lbs.



HF 2.6.9
 Ends : 9/16" Rd.
 Height: 44"
 Wt. 4.2 lbs.



HF 2.6.7
 Ends : 9/16" Rd.
 Tapered
 Height: 44"
 Wt. 3.8 lbs.



HF 2.9.21
 Ends : 9/16" Rd.
 Height: 44"
 Wt. 2.4 lbs.



HF 2.10.2
 Ends : 9/16" Rd.
 Height: 44"
 Wt. 3.2 lbs.



HF 2.10.4
 Ends : 9/16" Rd.
 Height: 44"
 Wt. 4.2 lbs.



HF 2.10.3
 Ends : 9/16" Rd.
 Height: 44"
 Wt. 3.6 lbs.



HF 2.11.40
 Ends : 9/16" Rd.
 Height: 44"
 Wt. 4 lbs.



HF 2.11.41
 Ends : 9/16" Rd.
 Height: 44"
 Wt. 5.2 lbs.

TUSCAN

SQUARE HAMMERED



Finishes & Patinas



RAW IRON (RAW)



SATIN BLACK (STB)



COPPER VEIN (CV)



OIL RUBBED BRONZE (ORB)



SATIN CLEAR (SC)



VINTAGE BRASS (VB)

	NEWELS	HF1.1.10	HF1.1.11	HF1.1.14	HF1.1.14-T	HF1.1.15	HF1.1.15-T	BALUSTERS	HF2.9.12	HF2.9.11	HF2.9.13	HF2.9.3	HF2.9.4	HF2.9.8	HF2.9.5	HF2.9.6	HF2.1.2	HF2.1.1	HF2.9.20	HF2.9.20-T	HF2.9.28	HF2.9.28-T	HF2.9.27	HF2.9.26	HF2.9.26-T	HF2.9.29	HF2.9.36	HF2.9.37
RAW		•	•	•		•			•	•	•	•	•	•	•	•			•		•	•	•	•				
STB		•	•	•	•	•	•		•	•	•	•	•	•	•	•			•	•	•	•	•	•	•	•	•	•
CV				•		•			•	•	•			•					•		•		•	•				
ORB		•	•	•	•	•	•		•	•	•	•	•	•	•	•			•	•	•	•	•	•	•	•	•	•
SC										•	•			•					•		•		•	•				
VB			•	•		•			•	•	•			•					•		•	•	•	•				

ACCESSORIES

- Level base shoes
- Level base collars
- Angled base shoes
- Adjustable level base shoes
- Adjustable angled base shoes
- Newel mounting kit

- HF16.3.25
- HF16.3.41, HF16.3.42
- HF16.3.28
- HF16.3.44, HF16.3.46
- HF16.3.45, HF16.3.47
- HF16.3.31

- Photos: C.
- Photos: D. H.
- Photos: G.
- Photos: R.
- Photos: S.
- Photos: T.

For photos and full accessory details see pages 46-47





NEWEL

15-1/2"

8-1/2"

23-1/4"

HF 1.1.10
Ends : 1" Sq.
Tapered
Height: 47-1/4"
Wt. 18 lbs.



NEWEL

16-1/4"

7"

24"

HF 1.1.11
Ends : 1" Sq.
Tapered
Height: 47-1/4"
Wt. 18 lbs.



NEWEL

47-1/4"

HF 1.1.14
Ends : 1" Sq.
Height: 47-1/4"
Wt. 18 lbs.
SOLID



NEWEL

17-1/8"

5"

25-1/8"

HF 1.1.14-T
Ends : 1" Sq.
Height: 47-1/4"
Wt. 2.30 lbs.
TUBULAR



NEWEL

17-1/8"

4-1/2"

22"

HF 1.1.15
Ends : 1" Sq.
Height: 47-1/4"
Wt. 18 lbs.
SOLID



NEWEL

17-1/2"

4-1/2"

22"

HF 1.1.15-T
Ends : 1" Sq.
Height: 47-1/4"
Wt. 5.30 lbs.
TUBULAR



NEWEL

12-1/2"

14-1/2"

17"

HF 2.9.12
Ends : 9/16" Sq.
Tapered
Height: 44"
Wt. 3.8 lbs.

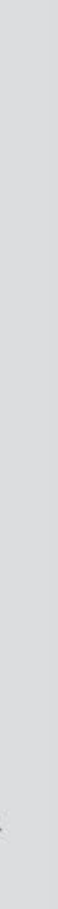

NEWEL

10"

4-1/2"

10-1/2"

4-1/2"

14-1/2"

HF 2.9.11
Ends : 9/16" Sq.
Height: 44"
Wt. 5 lbs.

NEWEL

10"

4-1/2"

10-1/2"

4-1/2"

14-1/2"

HF 2.9.13
Ends : 9/16" Sq.
Tapered
Height: 44"
Wt. 5.5 lbs.



HF 2.9.3
Ends : 9/16" Sq.
Height: 44"
Wt. 3.4 lbs.



HF 2.9.4
Ends : 9/16" Sq.
Height: 44"
Wt. 3.8 lbs.



HF 2.9.8
Ends : 9/16" Sq.
Height: 44"
Wt. 5.2 lbs.



HF 2.9.5
Ends : 9/16" Sq.
Height: 44"
Wt. 3.5 lbs.



HF 2.9.6
Ends : 9/16" Sq.
Height: 44"
Wt. 3.8 lbs.



HF 2.1.2
Ends : 9/16" Sq.
Height: 44"
Wt. 4 lbs.



HF 2.1.1
Ends : 9/16" Sq.
Height: 44"
Wt. 4.5 lbs.



HF 2.9.20
Ends : 9/16" Sq.
Height: 44"
Wt. 3 lbs.
SOLID
HF 2.9.20-T
Ends : 9/16" Sq.
Height: 44"
Wt. 1.05 lbs.
TUBULAR



HF 2.9.28
Ends : 9/16" Sq.
Height: 44"
Wt. 3.2 lbs.
SOLID
HF 2.9.28-T
Ends : 9/16" Sq.
Height: 44"
Wt. 2.35 lbs.
TUBULAR



HF 2.9.27
Ends : 9/16" Sq.
Height: 44"
Wt. 4.2 lbs.



HF 2.9.26
Ends : 9/16" Sq.
Height: 44"
Wt. 3.8 lbs.
SOLID
HF 2.9.26-T
Ends : 9/16" Sq.
Height: 44"
Wt. 1.95 lbs.
TUBULAR



HF 2.9.29
Ends : 9/16" Sq.
Height: 44"
Wt. 2.8 lbs.



HF 2.9.36
Ends : 9/16" Sq.
Height: 44"
Wt. 4.2 lbs.



HF 2.9.37
Ends : 9/16" Sq.
Height: 44"
Wt. 3.4 lbs.

ORLEANS



Oil Rubbed Bronze (shown)

House of Forgings is pleased to feature our Orleans Series balusters which is a tribute to the renowned culture, customs and architecture of the great city of New Orleans. These exclusive designs are available with single or double elements and finished in Oil Rubbed Bronze and Vintage Brass patinas.

Orleans



Vintage Brass (shown)

Oil Rubbed Bronze (shown)

ORLEANS

SQUARE HAMMERED



Finishes & Patinas



RAW IRON
(RAW)



OIL RUBBED
BRONZE
(ORB)



VINTAGE
BRASS
(VB)



NEWEL

47"

HF 1.1.14
Ends : 1" Sq.
Height: 47"
Wt. 18 lbs.



44"

HF 2.9.20
Ends : 9/16" Sq.
Height: 44"
Wt. 3 lbs.



12-1/2"

8-1/2"

23"

HF 2.9.23
Ends : 9/16" Sq.
Height: 44"
Wt. 3.5 lbs.



5-1/2"

8-1/2"

5-1/4"

8-1/2"

16-1/4"

HF 2.9.24
Ends : 9/16" Sq.
Height: 44"
Wt. 3.9 lbs.

ACCESSORIES

Level base shoes

Level base collars

Angled base shoes

Adjustable level base shoes

Adjustable angled base shoes

Newel mounting kit

HF16.3.25

HF16.3.41, HF16.3.42

HF16.3.28

HF16.3.44, HF16.3.46

HF16.3.45, HF16.3.47

HF16.3.31

Photos: C.

Photos: D. H.

Photos: G.

Photos: R.

Photos: S.

Photos: T.

For photos and full accessory details see pages 46-47



MONTE CARLO



Oil Rubbed Bronze (shown)

Drawing inspiration from the great Roman columns, the Monte Carlo series stands alone in style and elegance. The robust designs compliment the prominence of even the grandest estates. The intricately cast components are highlighted by the Oil Rubbed Bronze patina.

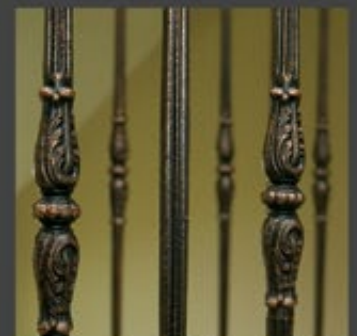

Oil Rubbed Bronze (shown)

MONTE CARLO

ROUND



Finishes & Patinas



SATIN BLACK (STB)



OIL RUBBED BRONZE (ORB)



NEWEL

HF 18.1.1-T
Ends : 1-3/16" Rd.
Height: 48"
Wt. 18.55 lbs.
TUBULAR

*Middle section is hollow cast iron, ends are hollow cast steel



HF 18.2.1-T
Ends : 5/8" Rd.
Height: 44"
Wt. 1.75 lbs.
TUBULAR

*Middle section is hollow cast aluminum, ends are hollow cast steel



HF 18.2.2-T
Ends : 5/8" Rd.
Height: 44"
Wt. 1.50 lbs.
TUBULAR

ACCESSORIES

Level base shoes
Angled base shoes
Newel mounting kit

HF16.3.50
HF16.3.51
HF16.3.14

Photos: I.
Photos: M.
Photos: U.

For photos and full accessory details see pages 46-47



ENDECOR



Vintage Brass (shown)

A House of Forgings exclusive, the Endecor® balustrade system has been featured by some of the top homebuilders in the nation. For the discerning client who wants to stand apart, these balusters are truly unique in form and function.

US D672,064 S
BALUSTER END PIECE



Satin Black (shown)



Additional U.S and Canadian patents pending.

ENDECOR®

SQUARE



Finishes & Patinas



SATIN BLACK
(STB)



OIL RUBBED
BRONZE
(ORB)



VINTAGE
BRASS
(VB)

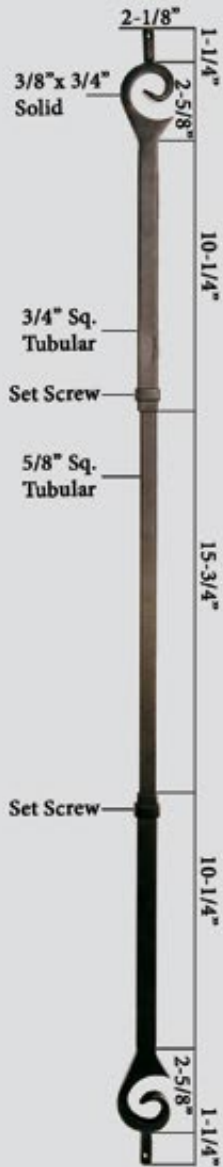

HF16.7.1
Ends : 9/16" Rd.
Height: 44"
Wt. 3.8 lbs.

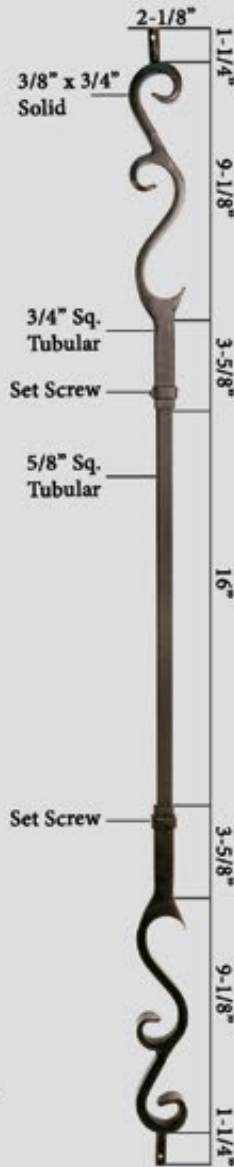

HF16.7.2
Ends : 9/16" Rd.
Height: 44"
Wt. 3.8 lbs.

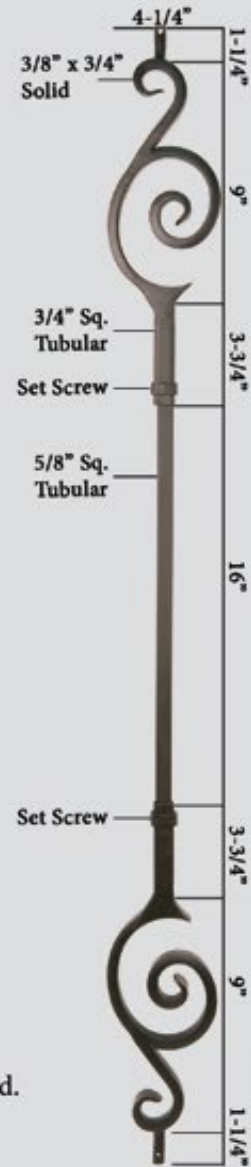

HF16.7.3
Ends : 9/16" Rd.
Height: 44"
Wt. 3.8 lbs.

↑
US D672,064 S
BALUSTER END PIECE

Additional U.S and Canadian patents pending.

DESIGNER



Oil Rubbed Bronze (shown)

The designer series offers an upgraded look at an affordable price for homebuilders and homeowners alike. These hollow balusters are offered in square or round and compliment a wide range of architectural styles.

Oil Rubbed Bronze (shown)



Oil Rubbed Bronze (shown)

DESIGNER TUBULAR



Finishes & Patinas

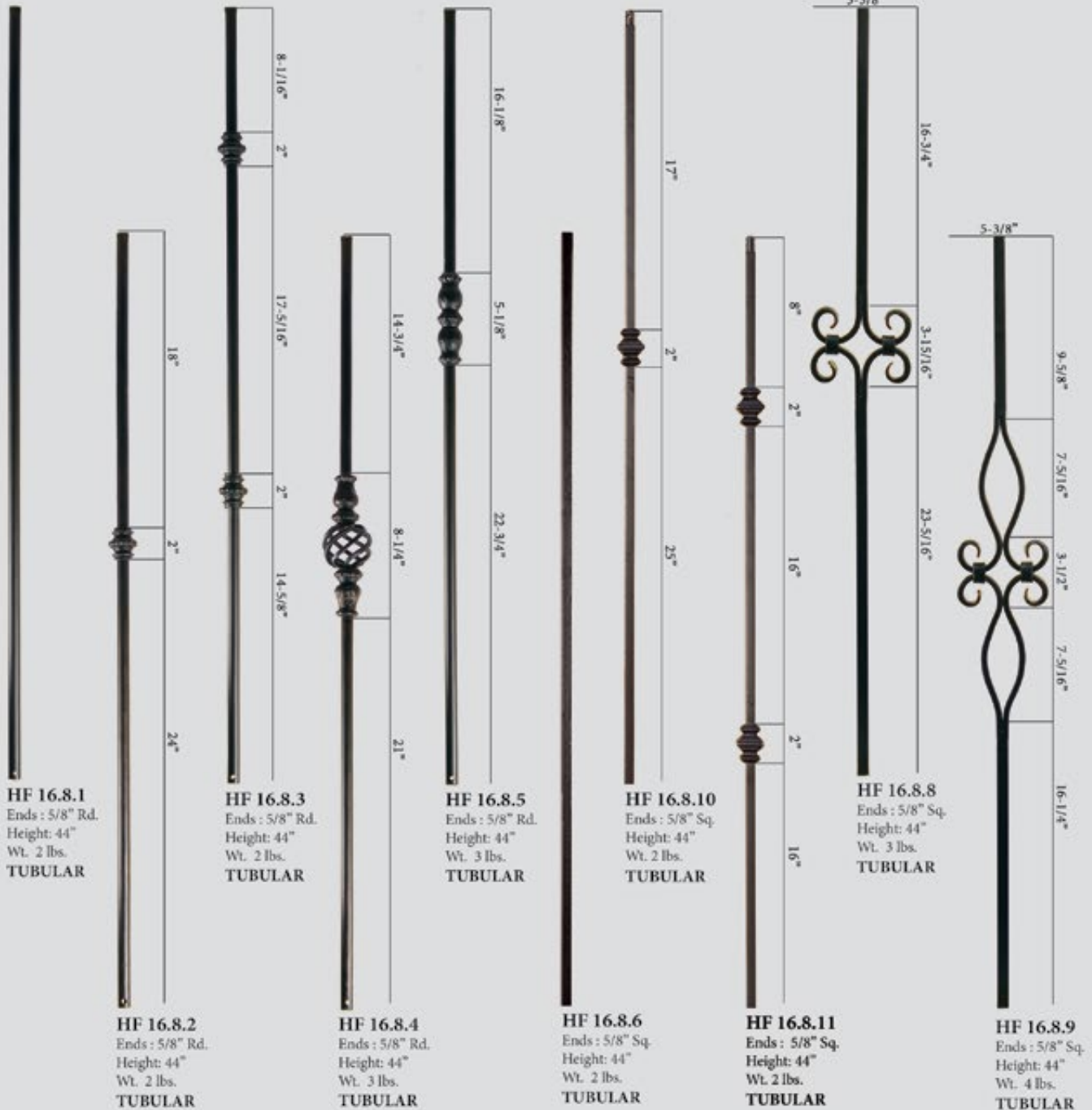

ACCESSORIES

Level base shoes
Angled base shoes

HF16.3.35, HF16.3.38
HF16.3.36, HF16.3.39

Photos: J. C.
Photos: N. G.

For photos and full accessory details see pages 46-47



STAINLESS STEEL



Stainless steel is a mainstay in the modern and contemporary home decor market. The simple, honest lines of this profile is the perfect compliment to your urban dwelling. Now, offered in a more affordable tubular style for the budget savvy buyer.

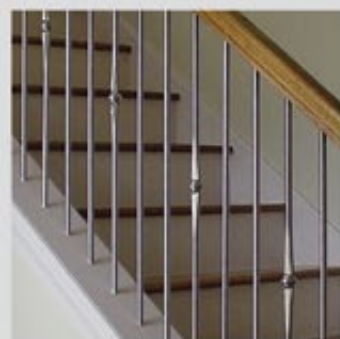

STAINLESS STEEL

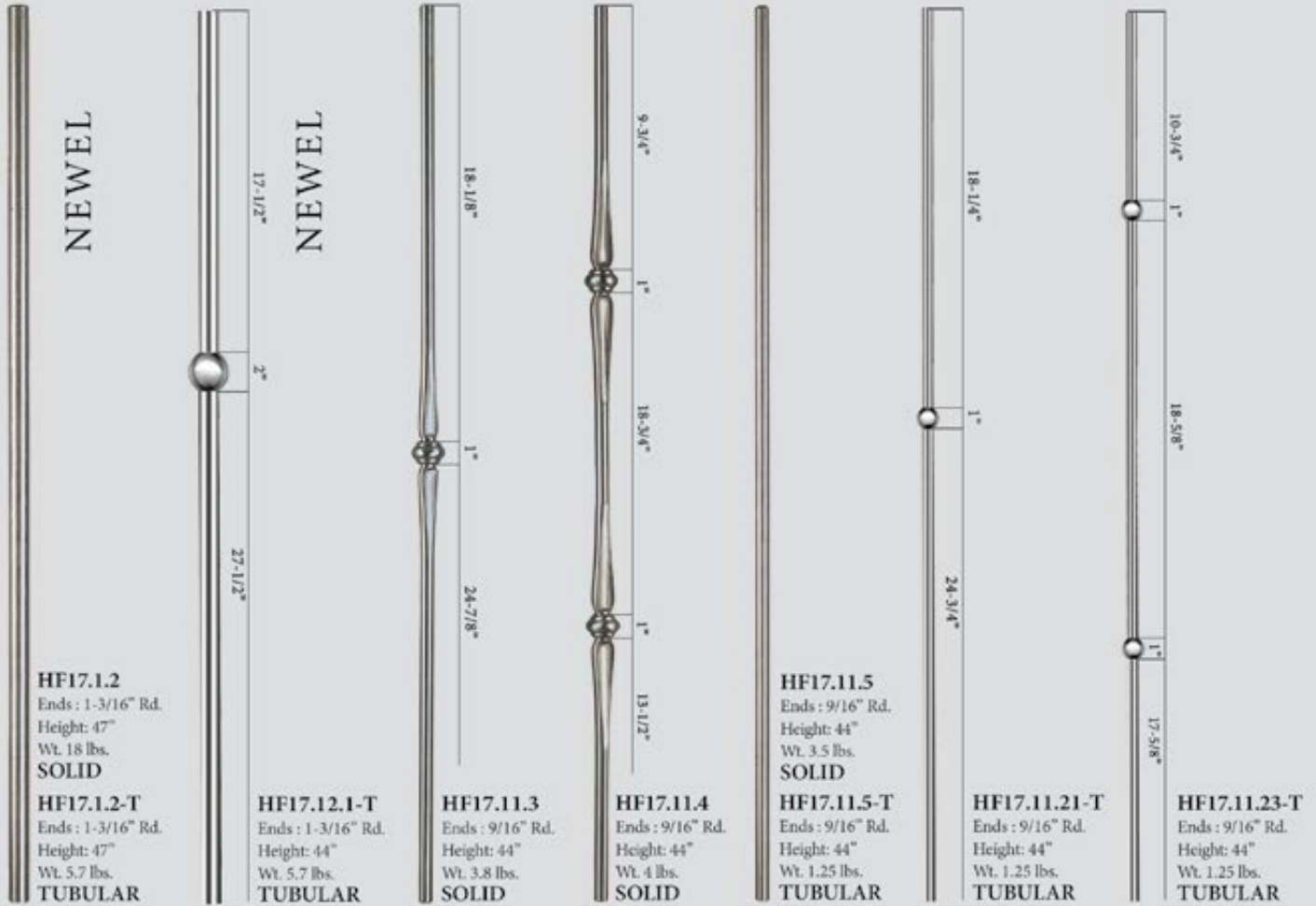

ACCESSORIES

Level base collar
Newel mounting kit

HF17.11.22
HF17.2.3

Photos: L.
Photos: V.

For photos and full accessory details see pages 46-47





SANTA FE

Satin Black (shown)

Our Santa Fe collection of edge hammered balusters are reminiscent of the old world Spanish architecture found in rustic Mexican villas. The bold, distinct hammering is the key to turning your home into an impressive estate.

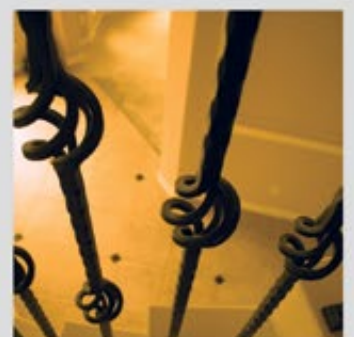

Satin Black (shown)

SANTA FE

SQUARE EDGE HAMMERED



Finishes & Patinas



HF 16.3.8
Ends : 9/16" Sq.
Height: 44"
Wt. 3.7 lbs.



HF 16.1.26
Ends : 9/16" Sq.
Height: 44"
Wt. 4 lbs.



HF 16.1.27
Ends : 9/16" Sq.
Height: 44"
Wt. 4.5 lbs.



HF 16.1.15
Ends : 9/16" Sq.
Height: 44"
Wt. 3 lbs.



HF 16.1.22
Ends : 9/16" Sq.
Height: 44"
Wt. 3.6 lbs.

ACCESSORIES

Level base shoes

Angled base shoes

Adjustable level base shoes

Adjustable angled base shoes

HF16.3.3

HF16.3.17

HF16.3.44, HF16.3.46

HF16.3.45, HF16.3.47

Photos: A.

Photos: E.

Photos: R.

Photos: S.

For photos and full accessory details see pages 46-47





GOTHIC

Oil Rubbed Copper (shown)

The inspiration for our Gothic series was the timeless ironwork featured in many European castles and estates. These prominent designs will compliment old world hardware and fixtures found throughout many homes today.

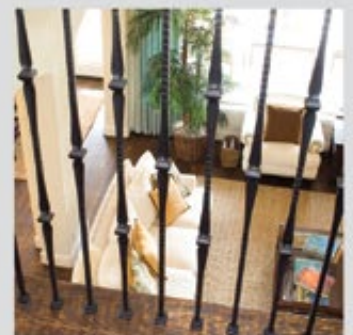

Oil Rubbed Copper (shown)

GOTHIC

Square Face Hammered



Finishes & Patinas



RAW IRON
(RAW)



SATIN BLACK
(STB)



COPPER VEIN
(CV)



OIL RUBBED
BRONZE
(ORB)



OIL RUBBED
COPPER
(ORC)



HF 16.5.6
Ends : 1-3/16" Sq.
Height: 48"
Wt. 22 lbs.

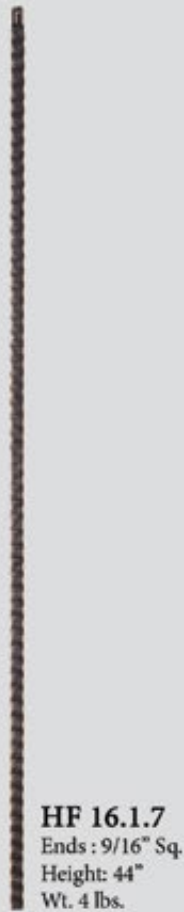

HF 16.1.7
Ends : 9/16" Sq.
Height: 44"
Wt. 4 lbs.



HF 16.5.2
Ends : 9/16" Sq.
Height: 44"
Wt. 3.5 lbs.



HF 16.1.8
Ends : 9/16" Sq.
Height: 44"
Wt. 3.8 lbs.



HF 16.1.9
Ends : 9/16" Sq.
Height: 44"
Wt. 4.5 lbs.

ACCESSORIES

- Level base shoes
- Level base collars
- Angled base shoes
- Adjustable level base shoes
- Adjustable angled base shoes
- Newel mounting kit

- HF16.3.3, HF16.3.20, HF16.3.25**
- HF16.3.41, HF16.3.42**
- HF16.3.17, HF16.3.28**
- HF16.3.44, HF16.3.46**
- HF16.3.45, HF16.3.47**
- HF16.2.3**

- Photos: A. A. C.
- Photos: D. H.
- Photos: E. G.
- Photos: R.
- Photos: S.
- Photos: T.

For photos and full accessory details see pages 46-47





Satin Black (shown)

The style of this collection provides a sleek appearance that strikes a perfect balance between traditional and contemporary.

Antique Nickel (shown)

ROUND



Oil Rubbed Bronze (shown)



Copper Vein (shown)



Copper Vein (shown)

ROUND

ROUND SMOOTH



Finishes & Patinas



RAW IRON
(RAW)



SATIN BLACK
(STB)



COPPER VEIN
(CV)



OIL RUBBED
BRONZE
(ORB)

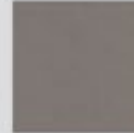

ASH GREY
(AG)

	NEWELS	HF16.5.10	HF16.5.11	HF16.5.11-T	HF1.1.19	BALUSTERS	HF16.2.2	HF16.1.17	HF16.1.18	HF16.1.19	HF16.1.20	HF16.1.25-R	HF2.11.3	HF2.11.3-T	HF2.11.4	HF2.11.4-T	HF2.11.16	HF2.11.16-T	HF2.8.18	HF16.8.1	
RAW			•		•		•					•	•	•	•	•	•	•	•	•	
STB		•	•		•		•	•	•	•	•	•	•	•	•	•	•	•	•		•
CV		•	•				•	•	•	•	•	•									
ORB			•		•							•	•	•	•	•	•	•	•	•	
AG				•										•		•					•



HF 16.5.10
Ends : 1-3/16" Rd.
Height: 48"
Wt. 19 lbs.



HF 16.5.11
Ends : 1-3/16" Rd.
Height: 48"
Wt. 19 lbs.
SOLID

HF 16.5.11-T
Ends : 1-3/16" Rd.
Height: 48"
Wt. 5.7 lbs.
TUBULAR

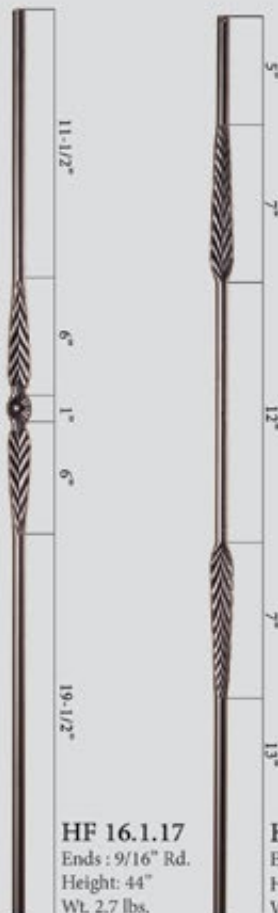



ACCESSORIES

- Level base shoes **HF16.3.13, HF16.3.26**
- Level base collars **HF16.3.40, HF16.3.43**
- Angled base shoes **HF16.3.16, HF16.3.27**
- Adjustable level base shoes **HF16.3.44, HF16.3.46**
- Adjustable angled base shoes **HF16.3.45, HF16.3.47**
- Level base shoe, fits 5/8" **HF16.3.35**
- Angled base shoe, fits 5/8" **HF16.3.36**
- Newel mounting kit **HF16.3.14, HF16.3.33**

- Photos: L. J.
- Photos: K. O.
- Photos: M. N.
- Photos: R.
- Photos: S.
- Photos: J.
- Photos: N.
- Photos: U.

For photos and full accessory details see pages 46-47 



Copper Vein (shown)

The endless baluster combinations in this series offers a match for your individual taste and style. These balusters compliment our Scroll, Twist and Ribbon series.

Silver Vein (shown)

VERSATILE

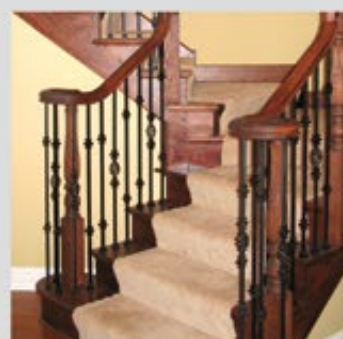

VERSATILE SQUARE



Finishes & Patinas



	NEWELS	HF16.5.8	HF16.5.8-T	HF16.5.9	HF16.5.9-T	BALUSTERS	HF16.2.1	HF16.2.1-T	HF16.2.1-50	HF16.1.34	HF16.1.34-T	HF16.1.35	HF16.1.35-T	HF16.1.45	HF16.1.45-T	HF2.10.1	HF2.2.3	HF16.1.25	HF16.1.25-T	HF16.1.25-S
RAW		•		•			•	•		•	•	•	•				•	•	•	
STB		•		•			•	•	•	•	•	•	•	•	•		•	•	•	•
AG			•		•			•			•		•						•	
SP		•		•			•	•		•	•	•	•						•	
CV		•		•			•	•		•	•	•	•	•	•				•	
ORB		•		•			•	•		•	•	•	•	•	•				•	
ORC		•		•			•	•		•	•	•	•	•	•				•	
AN		•		•			•			•		•		•				•		

NEWEL



HF 16.5.8
Ends : 1-3/16" Sq.
Height: 48"
Wt. 19 lbs.
SOLID

HF 16.5.8-T
Ends : 1-3/16" Sq.
Height: 48"
Wt. 4.8 lbs.
TUBULAR

NEWEL



HF 16.5.9
Ends : 1-3/16" Sq.
Height: 48"
Wt. 20 lbs.
SOLID

HF 16.5.9-T
Ends : 1-3/16" Sq.
Height: 48"
Wt. 9.7 lbs.
TUBULAR

NEWEL



HF 16.2.1
Ends : 1/2" Sq.
Height: 44"
Wt. 3 lbs.
SOLID

HF 16.2.1-T
Ends : 1/2" Sq.
Height: 44"
Wt. 1.2 lbs.
TUBULAR

HF 16.2.1-50
Ends : 1/2" Sq.
Height: 50"
Wt. 3.2 lbs.
SOLID

NEWEL



HF 16.1.34
Ends : 1/2" Sq.
Height: 44"
Wt. 4 lbs.
SOLID

HF 16.1.34-T
Ends : 1/2" Sq.
Height: 44"
Wt. 1.35 lbs.
TUBULAR

NEWEL



HF 16.1.35
Ends : 1/2" Sq.
Height: 44"
Wt. 3.5 lbs.
SOLID

HF 16.1.35-T
Ends : 1/2" Sq.
Height: 44"
Wt. 1.5 lbs.
TUBULAR

NEWEL



HF 16.1.45
Ends : 1/2" Sq.
Height: 44"
Wt. 4 lbs.
SOLID

HF 16.1.45-T
Ends : 1/2" Sq.
Height: 44"
Wt. 1.55 lbs.
TUBULAR



HF 2.10.1
Ends : 1/2" Sq.
Height: 44"
Wt. 4.2 lbs.



HF 2.2.3
Ends : 1/2" Sq.
Height: 44"
Wt. 3 lbs.



HF 16.1.25
Ends : 1/2" Sq.
Height: 44"
Wt. 5.2 lbs.
SOLID

HF 16.1.25-T
Ends : 1/2" Sq.
Height: 44"
Wt. 3.85 lbs.
TUBULAR



HF 16.1.25-S
Ends : 1/2" Sq.
Height: 44"
Wt. 5.2 lbs.

ACCESSORIES

Level base shoes	HF16.3.1, HF16.3.19, HF16.3.29
Level base collars	HF16.3.4, HF16.3.5,
Angled base shoes	HF16.3.2, HF16.3.30
Adjustable level base shoes	HF16.3.44, HF16.3.46
Adjustable angled base shoes	HF16.3.45, HF16.3.47
Versatile style knuckle	HF16.5.1
Newel mounting kit	HF16.2.3

Photos: A. A. C.
Photos: D. H.
Photos: E. G.
Photos: R.
Photos: S.
Photos: F.
Photos: T.

For photos and full accessory details see pages 46-47





Satin Black (shown)

The ribbon style twist in this series pairs nicely with balusters from the Scroll and Versatile series. The ribbon is accented nicely by the Oil Rubbed Bronze patina as well as the Copper Vein finish.

Copper Vein (shown)

RIBBON



RIBBON SQUARE



Finishes & Patinas



RAW IRON (RAW)



SATTN BLACK (STB)



COPPER VEIN (CV)



OIL RUBBED BRONZE (ORB)



OIL RUBBED COPPER (ORC)

	NEWELS	HF16.5.7	BALUSTERS	HF16.1.5	HF16.1.6	HF16.3.6	HF16.3.7	HF16.1.10	HF16.1.11
RAW		•		•	•				
STB		•		•	•	•	•	•	•
CV		•		•	•	•	•	•	•
ORB		•		•	•	•	•	•	•
ORC		•		•	•	•	•	•	•





HF 16.1.10
 Ends : 1/2" Sq.
 Height: 44"
 Wt. 3.6 lbs.



HF 16.1.11
 Ends : 1/2" Sq.
 Height: 44"
 Wt. 4.1 lbs.

ACCESSORIES

Level base shoes	HF16.3.1, HF16.3.19, HF16.3.29
Level base collars	HF16.3.4, HF16.3.5,
Angled base shoes	HF16.3.2, HF16.3.30
Adjustable level base shoes	HF16.3.44, HF16.3.46
Adjustable angled base shoes	HF16.3.45, HF16.3.47
Versatile style knuckle	HF16.5.1
Newel mounting kit	HF16.2.3

Photos: A. A. C.
 Photos: D. H.
 Photos: E. G.
 Photos: R.
 Photos: S.
 Photos: F.
 Photos: T.

For photos and full accessory details see pages 46-47





Copper Vein (shown)

This popular twist and basket design is a mainstay featured in many new homes. These balusters and newels are offered in an extensive range of finishes and patinas. They combine seamlessly with profiles from the Scroll and Versatile series.

Oil Rubbed Copper (shown)

TWIST



Satin Black (shown)

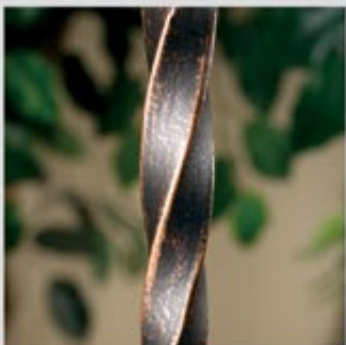

Oil Rubbed Bronze (shown)

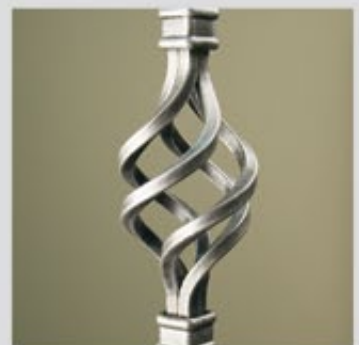

Antique Nickel (shown)

TWIST SQUARE



Finishes & Patinas



	NEWELS	HF16.5.4	HF16.5.4-T	HF16.5.5	HF16.5.5-T	BALUSTERS	HF16.1.1	HF16.1.1-T	HF16.1.2	HF16.1.2-T	HF16.1.3	HF16.1.3-T	HF16.1.4	HF16.1.4-T	HF16.1.21	HF16.1.21-T	HF16.1.16	HF16.2.4	HF16.2.5	HF16.2.6	HF16.1.41	
RAW		•		•			•	•	•	•	•	•	•	•	•	•		•	•	•		
STB		•		•			•	•	•	•	•	•	•	•	•	•		•	•	•	•	•
AG			•		•																	
SP		•		•			•	•	•	•	•	•	•	•	•	•		•	•	•	•	•
CV		•		•			•	•	•	•	•	•	•	•	•	•		•	•	•	•	•
ORB		•		•			•	•	•	•	•	•	•	•	•	•		•	•	•	•	•
ORC		•		•			•	•	•	•	•	•	•	•	•	•		•	•	•	•	•
AN		•		•			•	•	•	•	•	•	•	•	•	•		•	•	•	•	•



NEWEL

13-1/4"

11-1/2"

23-1/4"

HF 16.5.4
Ends : 1-3/16" Sq.
Height: 48"
Wt. 18 lbs.
SOLID

HF 16.5.4-T
Ends : 1-3/16" Sq.
Height: 48"
Wt. 5.5 lbs.
TUBULAR



NEWEL

5-1/2"

7-1/4"

3-1/2"

2-1/2"

6-1/2"

2-1/2"

3-1/2"

7-1/4"

14-1/2"

HF 16.5.5
Ends : 1-3/16" Sq.
Height: 48"
Wt. 20 lbs.
SOLID

HF 16.5.5-T
Ends : 1-3/16" Sq.
Height: 48"
Wt. 7.6 lbs.
TUBULAR



15"

6"

23"

HF 16.1.1
Ends : 1/2" Sq.
Height: 44"
Wt. 3 lbs.
SOLID

HF 16.1.1-T
Ends : 1/2" Sq.
Height: 44"
Wt. 1.2 lbs.
TUBULAR



6"

9"

9"

9"

17"

HF 16.1.2
Ends : 1/2" Sq.
Height: 44"
Wt. 3 lbs.
SOLID

HF 16.1.2-T
Ends : 1/2" Sq.
Height: 44"
Wt. 1.15 lbs.
TUBULAR



6"

6"

3"

5-1/2"

3-1/2"

6"

14"

HF 16.1.3
Ends : 1/2" Sq.
Height: 44"
Wt. 4 lbs.
SOLID

HF 16.1.3-T
Ends : 1/2" Sq.
Height: 44"
Wt. 1.55 lbs.
TUBULAR



8"

5-1/2"

8"

5-1/2"

17"

HF 16.1.4
Ends : 1/2" Sq.
Height: 44"
Wt. 4 lbs.
SOLID

HF 16.1.4-T
Ends : 1/2" Sq.
Height: 44"
Wt. 1.95 lbs.
TUBULAR

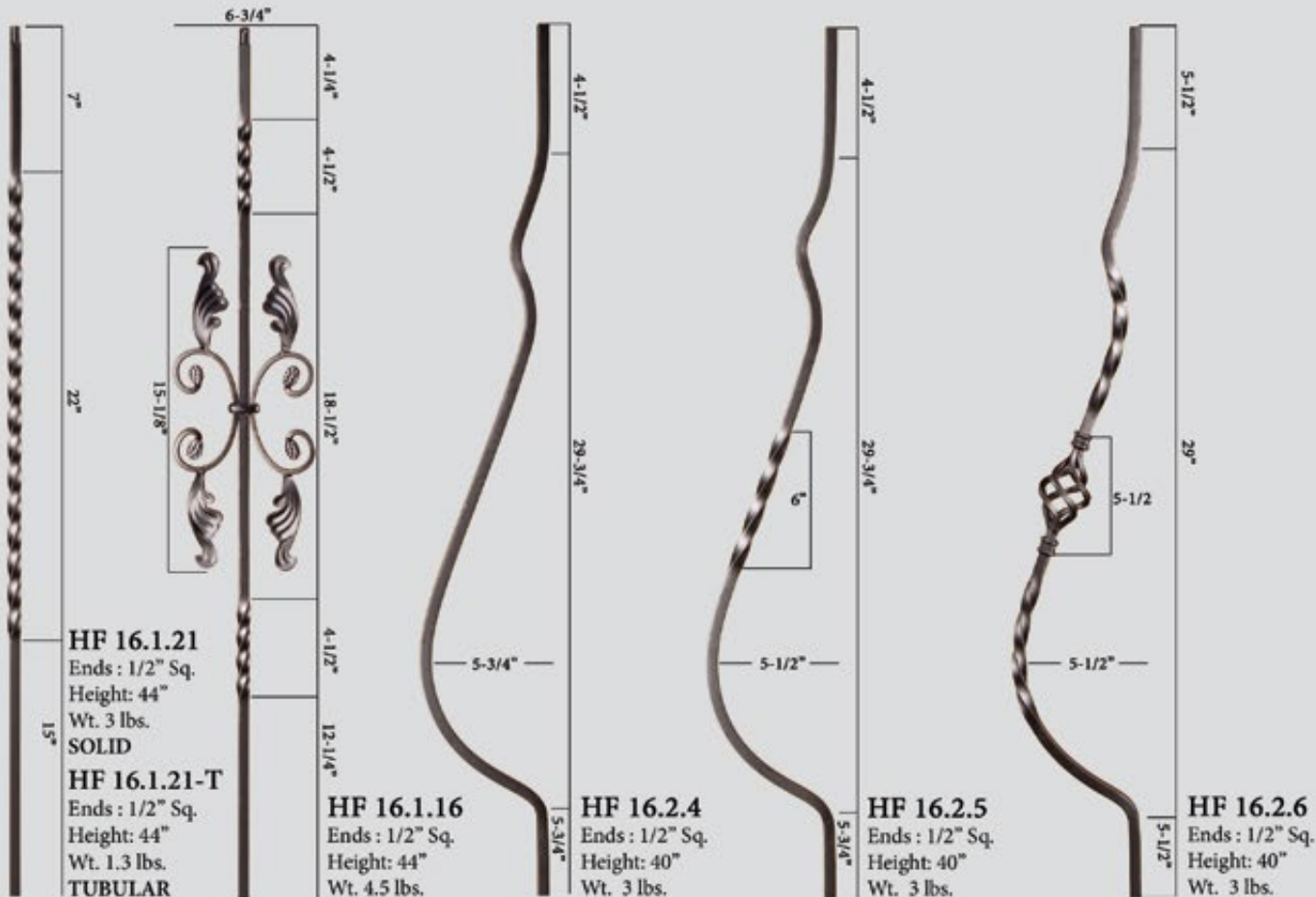

ACCESSORIES

- Level base shoes
- Level base collars
- Angled base shoes
- Adjustable level base shoes
- Adjustable angled base shoes
- Versatile style knuckle
- Newel mounting kit

- HF16.3.1, HF16.3.19, HF16.3.29**
- HF16.3.4, HF16.3.5,**
- HF16.3.2, HF16.3.30**
- HF16.3.44, HF16.3.46**
- HF16.3.45, HF16.3.47**
- HF16.5.1**
- HF16.2.3**

- Photos: A. A. C.
- Photos: D. H.
- Photos: E. G.
- Photos: R.
- Photos: S.
- Photos: F.
- Photos: T.

For photos and full accessory details see pages 46-47 

ACCESSORY SPECIFICATIONS

Photo	Part #	Description	RAW	STB	AG	SP	CV	ORB	ORC	AN	VB	SC
1/2" Square Baluster Accessories												
A.	HF16.3.1	Level base shoe, fits 1/2" square balusters, 1-5/16" square base, aluminum		•		•	•		•	•		
A.	HF16.3.19	Level base shoe with set screw, fits 1/2" square balusters, 1-5/16" square base, aluminum	•	•	•	•	•	•	•	•		
E.	HF16.3.2	Angled base shoe with set screw, fits 1/2" square balusters, 1-5/16" base, aluminum	•	•	•	•	•	•	•	•		
B.	HF16.3.21	Level base shoe with screw mount, fits 1/2" square balusters, 1-9/16" square base, aluminum		•			•					
F.	HF16.5.1	Versatile style knuckle with set screw, fits 1/2" square balusters, 1-7/16" square, aluminum	•	•		•	•	•	•	•		
C.	HF16.3.29	Oil Rubbed Bronze, level base shoe with set screw, fits 1/2" square balusters, 1-1/4" square base, cast iron		•				•				
G.	HF16.3.30	Oil Rubbed Bronze, angled base shoe with set screw, fits 1/2" square balusters, 1-1/4" base, cast iron						•				
D.	HF16.3.4	Level base collar, fits 1/2" square balusters, 2" square base, aluminum		•			•	•				
H.	HF16.3.5	Level base collar, fits 1/2" square balusters, 1-5/16" round base, aluminum		•			•	•	•			
9/16" Square Baluster Accessories												
A.	HF16.3.3	Level base shoe, fits 9/16" square balusters, 1-5/16" square base, aluminum		•			•	•				
A.	HF16.3.20	Level base shoe with set screw, fits 9/16" square balusters, 1-5/16" square base, aluminum		•			•	•	•			
E.	HF16.3.17	Angled base shoe with set screw, fits 9/16" square balusters, 1-5/16" base, aluminum		•			•	•	•			
C.	HF16.3.25	Level base shoe with set screw, fits 9/16" Tuscan square balusters, 1-1/4" square base, cast iron	•	•			•	•			•	•
G.	HF16.3.28	Angled base shoe with set screw, fits 9/16" Tuscan square balusters, 1-1/4" base, cast iron	•	•			•	•			•	•
D.	HF16.3.41	Level base collar, fits 9/16" square balusters, 2" square base, aluminum		•			•	•				
H.	HF16.3.42	Level base collar, fits 9/16" square balusters, 1-5/16" round base, aluminum		•				•			•	
5/8" Square Baluster Accessories												
C.	HF16.3.38	Level base shoe with set screw, fits 5/8" square balusters, 1-1/4" square base, cast iron	•	•				•				
G.	HF16.3.39	Angled base shoe with set screw, fits 5/8" square balusters, 1-1/4" base, cast iron	•	•				•				
9/16" Round Baluster Accessories												
I.	HF16.3.13	Level base shoe, fits 9/16" round balusters, 1-5/16" square base, aluminum		•			•					
M.	HF16.3.16	Angled base shoe with set screw, fits 9/16" round balusters, 1-5/16" base, aluminum		•			•					
J.	HF16.3.26	Level base shoe, fits 9/16" round balusters, 1-1/4" square base, cast iron		•			•	•			•	•
N.	HF16.3.27	Angled base shoe with set screw, fits 9/16" round balusters, 1-1/4" base, cast iron		•			•	•			•	•
K.	HF16.3.40	Level base collar, fits 9/16" round balusters, 2" square base, cast iron		•			•	•				
O.	HF16.3.43	Level base collar, fits 9/16" round balusters, 1-5/16" round base, cast iron		•				•			•	
L.	HF17.11.22	Level base collar, fits 9/16" round stainless steel balusters, 1-1/2" round base, stainless steel										
5/8" Round Baluster Accessories												
J.	HF16.3.35	Level base shoe with set screw, fits 5/8" round balusters, 1-1/4" square base, cast iron	•	•	•		•	•				
N.	HF16.3.36	Angled base shoe with set screw, fits 5/8" round balusters, 1-1/4" base, cast iron	•	•	•		•	•				
I.	HF16.3.50	Level base shoe with set screw, fits 5/8" round balusters, 1-5/16" square base, aluminum		•				•				
M.	HF16.3.51	Angled base shoe with set screw, fits 5/8" round balusters, 1-5/16" base, aluminum		•				•				
Adjustable Shoes/Collars have a flexible insert that allows them to be used with either square or round balusters ranging in size from 1/2" to 9/16". Epoxy must be used to permanently secure.												
R.	HF16.3.44	Level base shoe, fits 1/2" - 9/16" square or round balusters, 1-5/16" square base, cast iron		•			•	•			•	•
R.	HF16.3.46	Level base shoe, fits 1/2" - 9/16" square or round balusters, 1-1/2" square base, cast iron		•			•	•			•	•
S.	HF16.3.45	Angled base shoe, fits 1/2" - 9/16" square or round balusters, 1-5/16" base, cast iron		•			•	•			•	•
S.	HF16.3.47	Angled base shoe, fits 1/2" - 9/16" square or round balusters, 1-1/2" base, cast iron		•			•	•			•	•
P.	HF16.3.24	Level base collar, fits 1/2" - 9/16" square or round balusters, 1-11/16" square base, aluminum		•								
Q.	HF16.3.23	Level base collar, fits 1/2" - 9/16" square or round balusters, 1-11/16" round base, aluminum		•								
Newel Mounting Kits												
T.	HF16.2.3	Newel mounting kit with level base shoe, fits 1-3/16" square newels, 3-1/8" square base, cast iron	•	•	•	•	•	•	•	•		
T.	HF16.3.31	Newel mounting kit with level base shoe, fits 1" square newels, 3-1/8" square base, cast iron	•	•			•	•			•	•
U.	HF16.3.14	Newel mounting kit with level base shoe, fits 1-3/16" round newels, 3-1/8" square base, cast iron	•	•	•		•					
U.	HF16.3.33	Newel mounting kit with level base shoe, fits 1" round newels, 3-1/8" square base, cast iron	•	•	•		•				•	•
V.	HF17.2.3	Newel mounting kit with level base collar, fits 1-3/16" round stainless steel newels, 3-1/4" round base, stainless steel										
Handrail Brackets												
W.	HF3002	Handrail bracket, 1-1/4" x 2-3/8" mounting plate, extends out 3" from wall, aluminum Also available in Brushed Chrome HFBC3002, Polished Brass HFPB3002		•		•	•	•	•			•
X.	HF3003	Handrail bracket, 2-1/16" round mounting plate, extends out 3" from wall, aluminum Also available in Chrome HFCE3003, Brushed Chrome HFBC3003, Polished Brass HFPB3003, Nickel HFNL3003		•	•	•	•	•	•	•	•	•

ACCESSORY PROFILES



Forged Panels

**House of Forgings
is dedicated to
providing superior
products that meet the
highest standards of
architects,
homebuilders
and homeowners.**

We are pleased to provide a full line of prefabricated ornamental iron components. These elegant products allow for the look and feel of a fully custom fabricated iron stair or railing system. In addition to cost savings, installation time is greatly reduced compared to traditional fabrication.

STAIR & RAILING PRODUCTS BY





Rebecca panels paired with Monte Carlo balusters (shown)

REBECCA



Rebecca HFRB.B1 (shown)

5/8" ROUND IRON



1/2" ROUND IRON

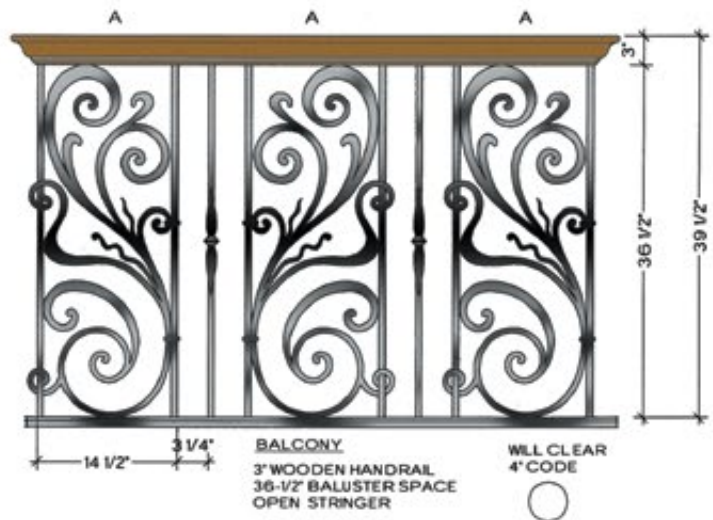
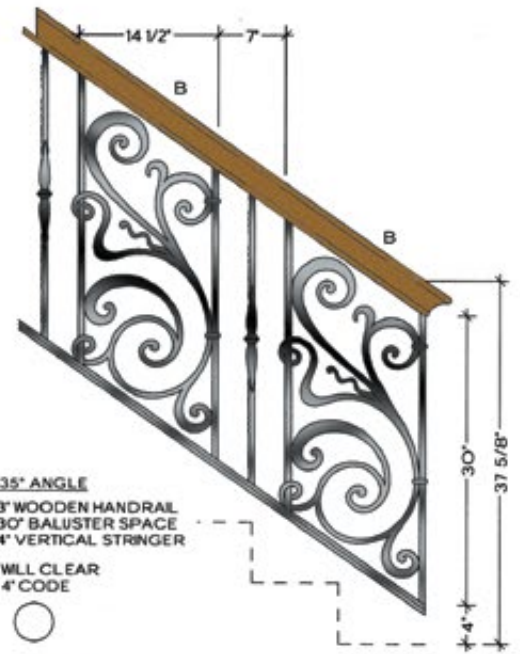

REBECCA

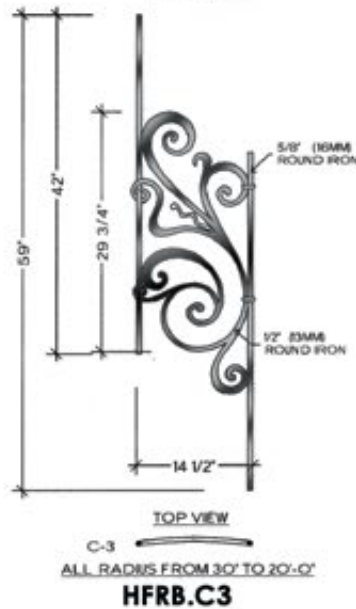
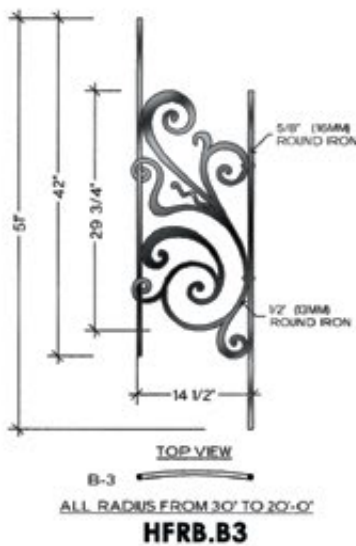
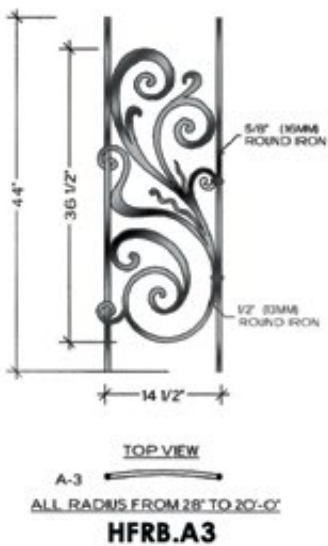
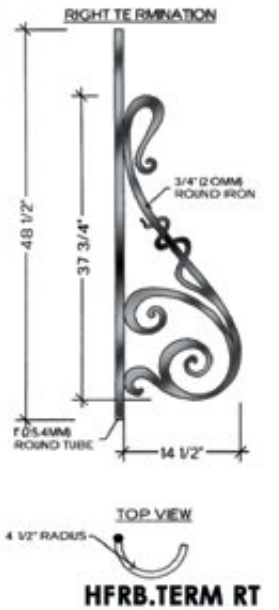
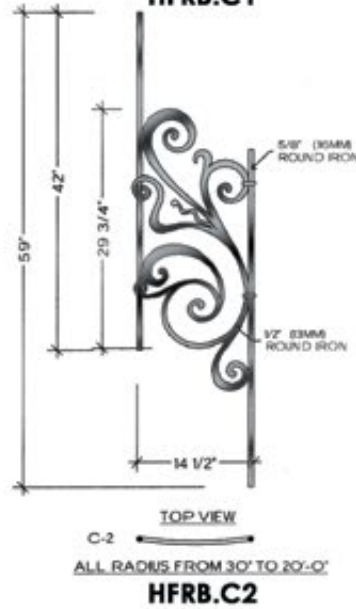
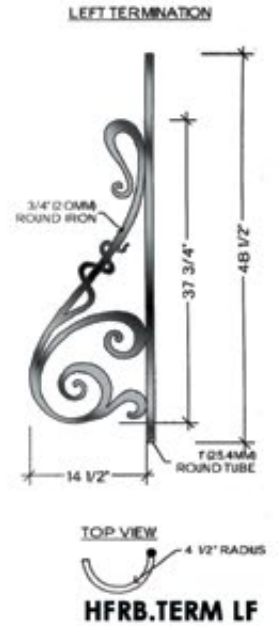
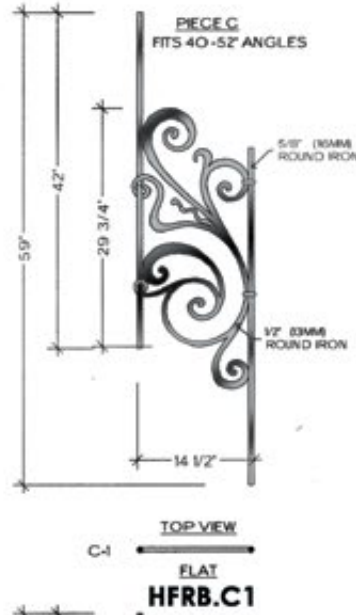
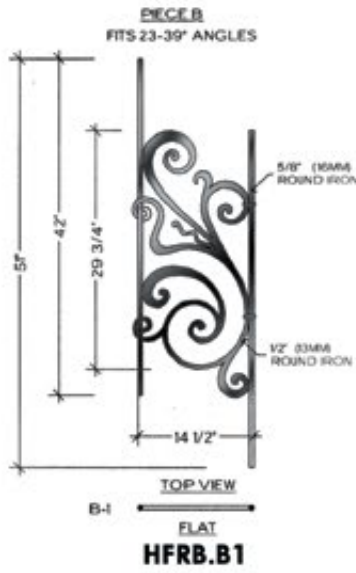
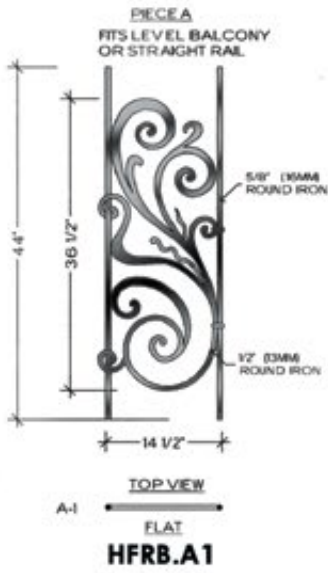

TUSCANY



Tuscany HFTU.A1 (shown)

1/2" SQUARE
IRON

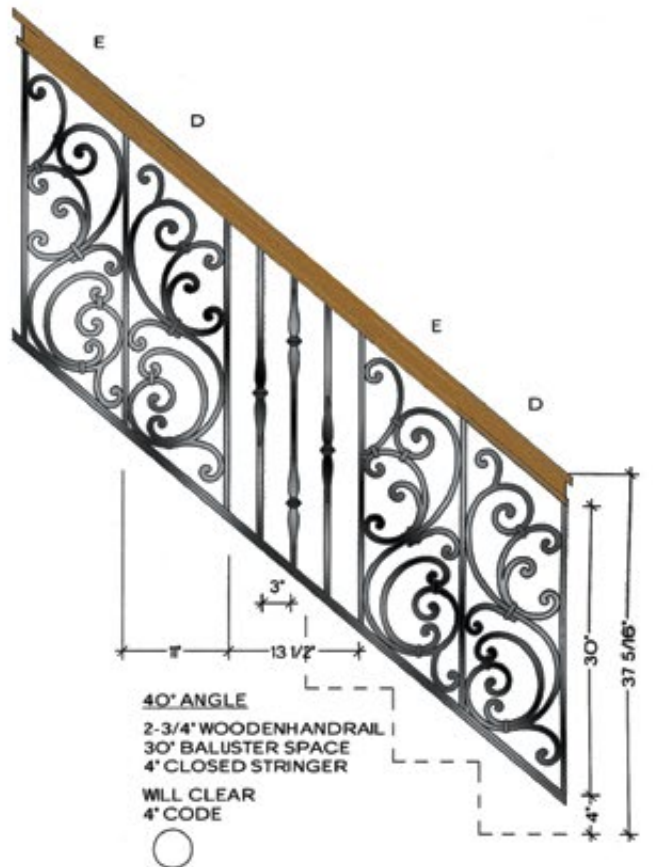
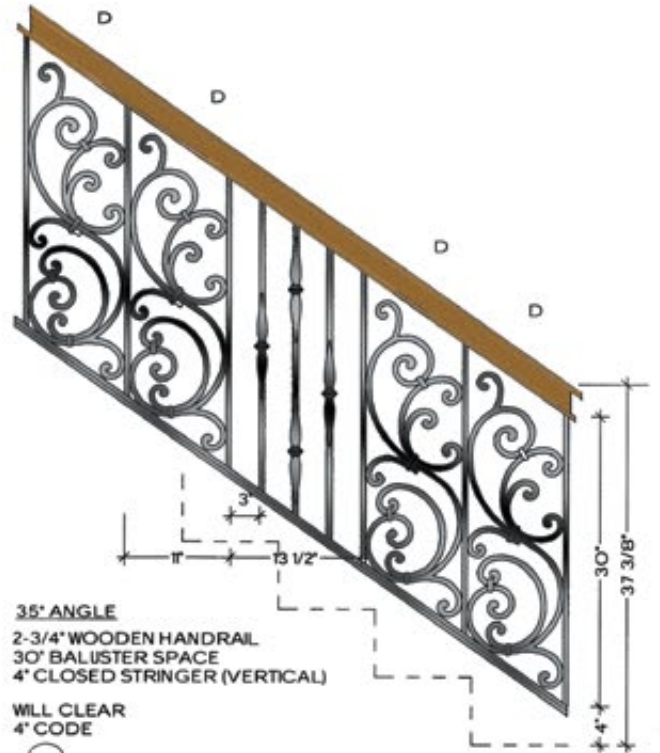

TUSCANY

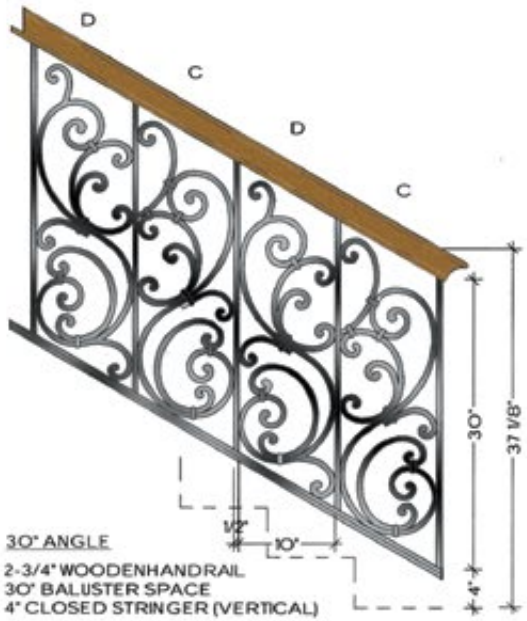

WILL CLEAR
 4" CODE



WILL CLEAR
 4" CODE



RIGHT TERMINATION
 LEFT SIDE VIEW

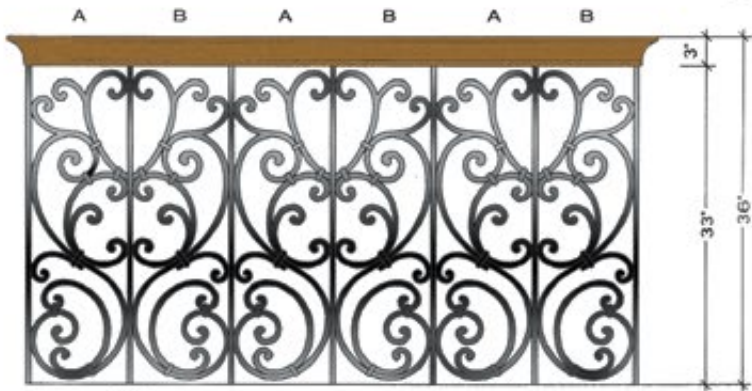

WILL CLEAR
 4" CODE

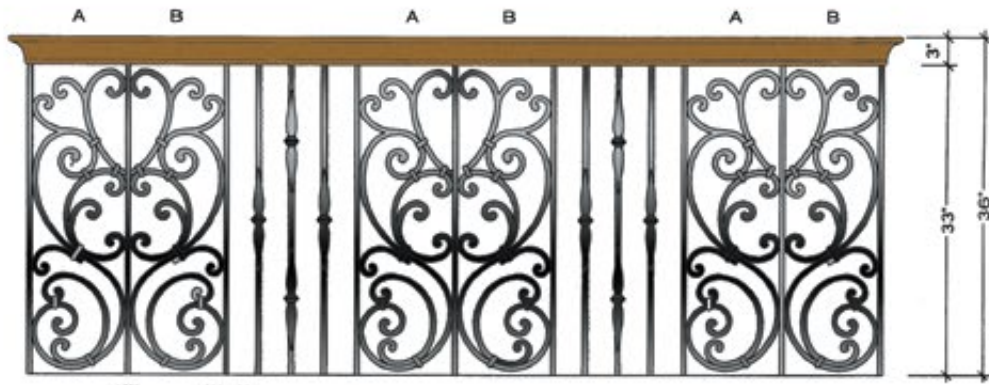

WILL CLEAR
 4" CODE



TUSCANY

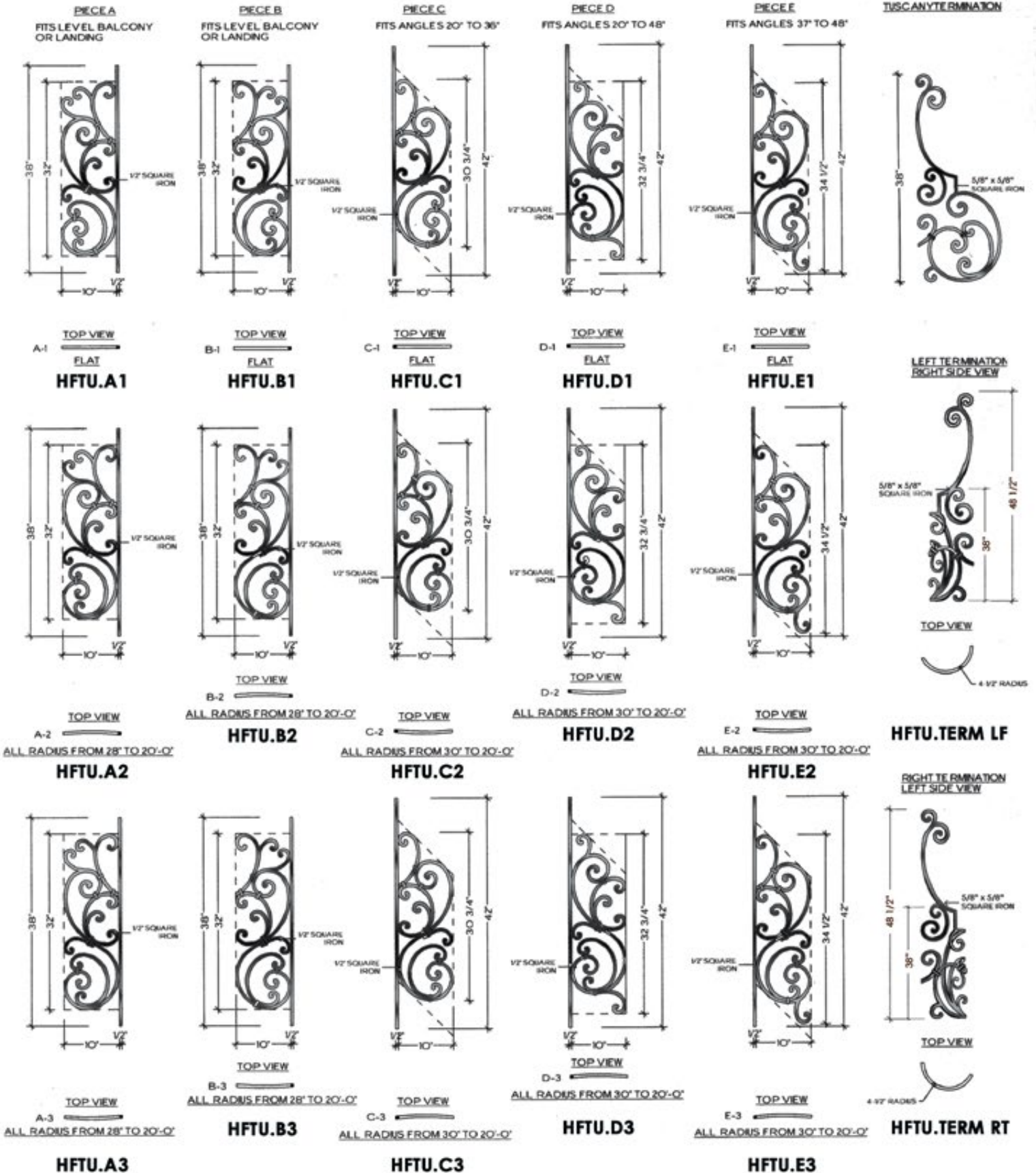



Tuscany panels paired with Gothic balusters (shown)

SEVILLE



Seville HFSE.A1 (shown)

1/2" SQUARE IRON



45° ANGLE
2-1/2" WOODEN HANDRAIL
30" BALUSTER SPACE
4" VERTICAL STRINGER

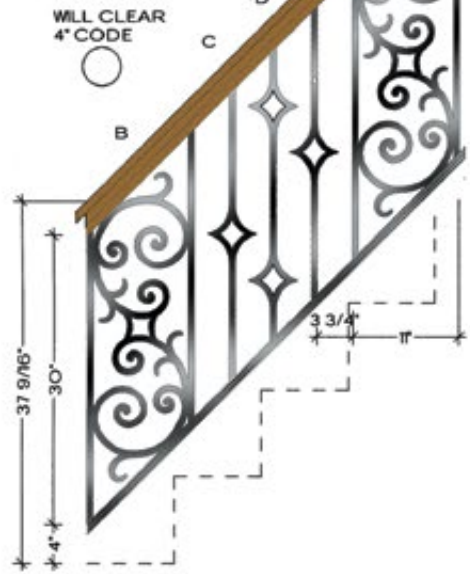

30° ANGLE
3" WOODEN HANDRAIL
30" BALUSTER SPACE
4" VERTICAL STRINGER

WILL CLEAR 4" CODE

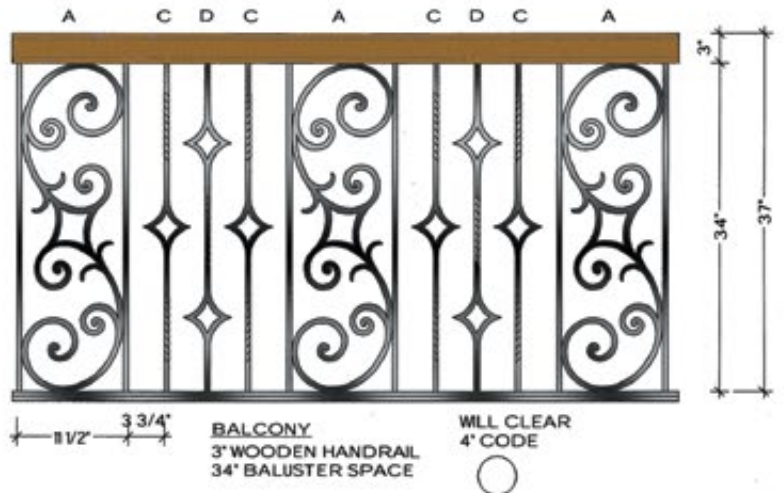
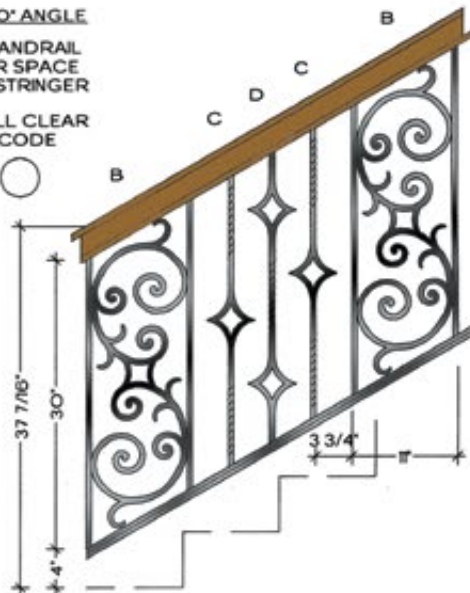

SEVILLE

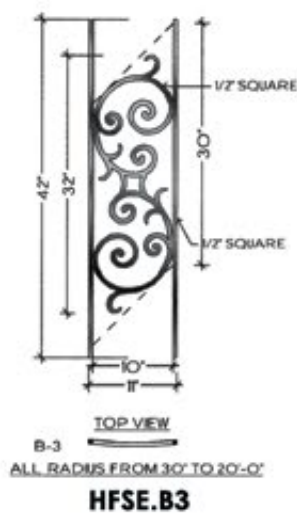
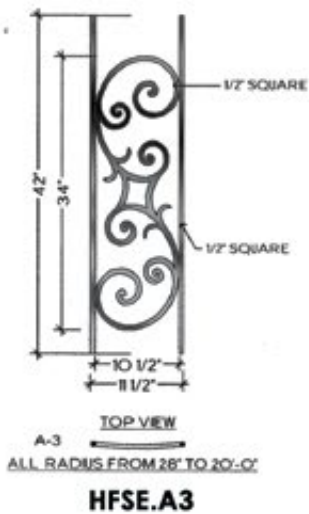
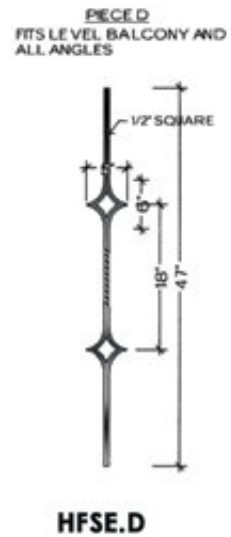
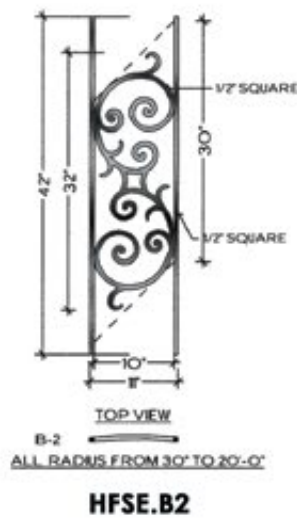
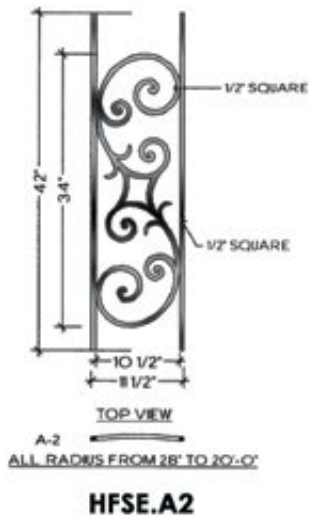
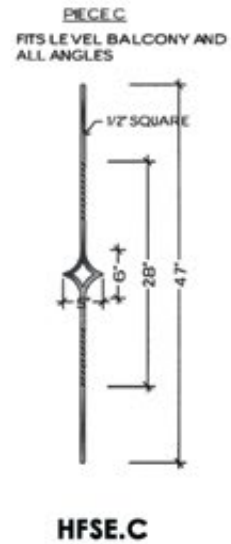
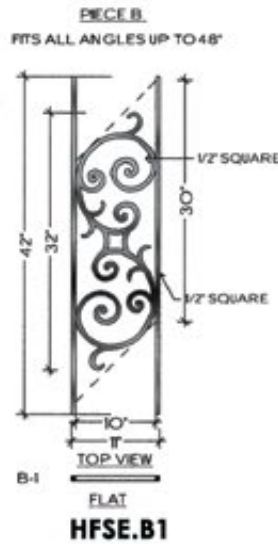
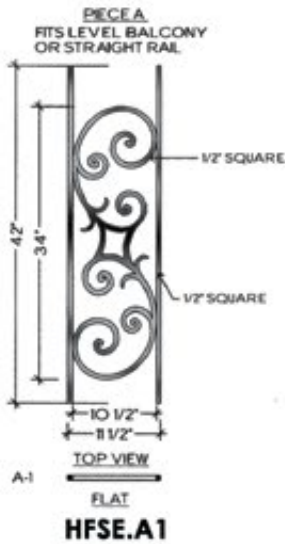

MILANO



Milano HFMO.A1 (shown)

3/4" SQUARE TUBE



1/2" SQUARE IRON

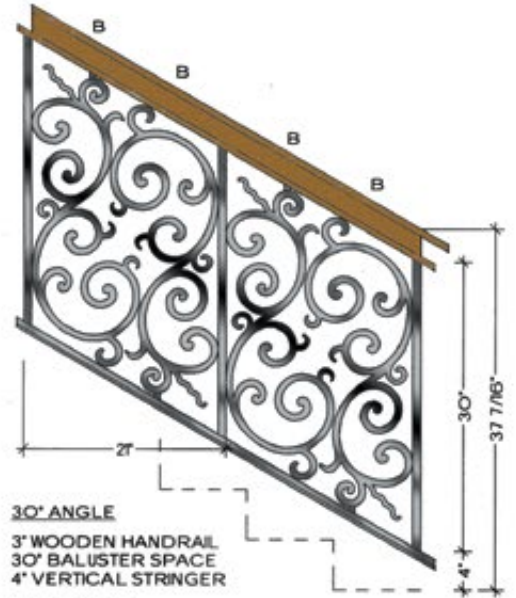

WILL CLEAR 4" CODE

"NOTE: THE MILANO LAYOUT REQUIRES THE REMOVAL OF SOME ATTACHED VERTICALS AND REWELDING SCROLLS TO PREVIOUS VERTICAL"

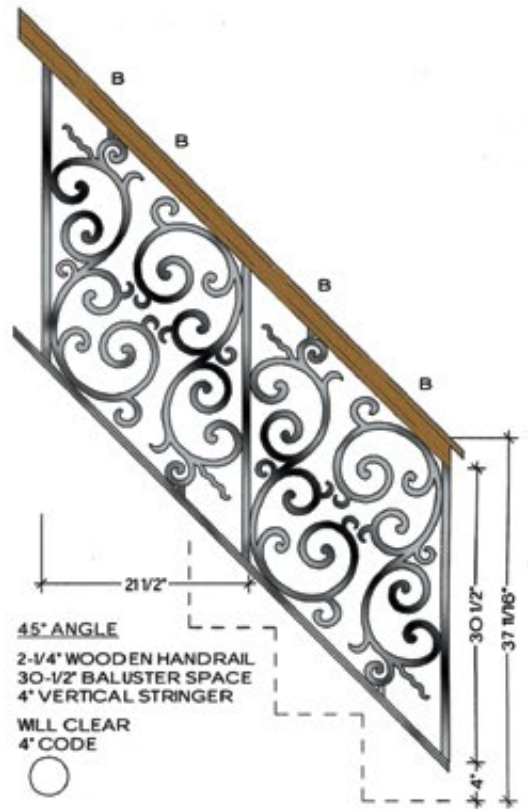

WILL CLEAR 4" CODE

MILANO

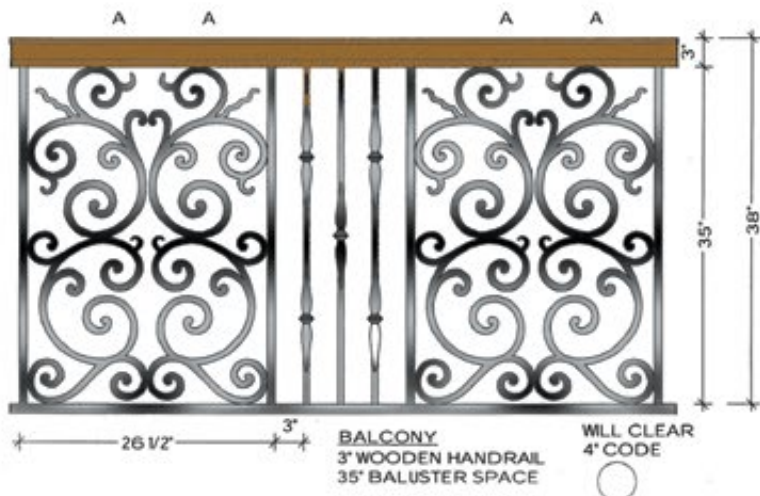
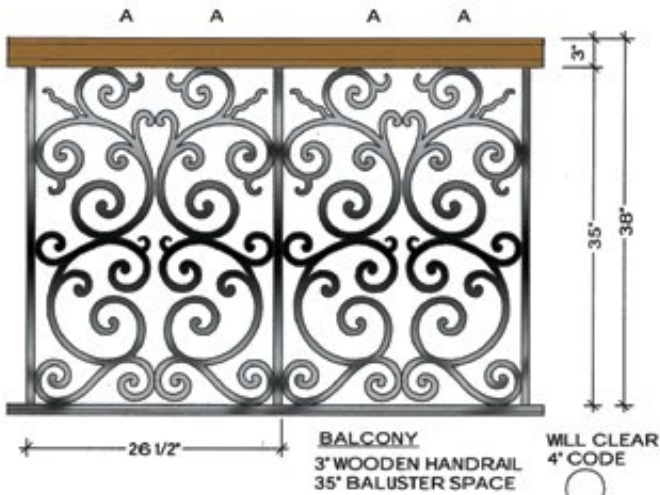
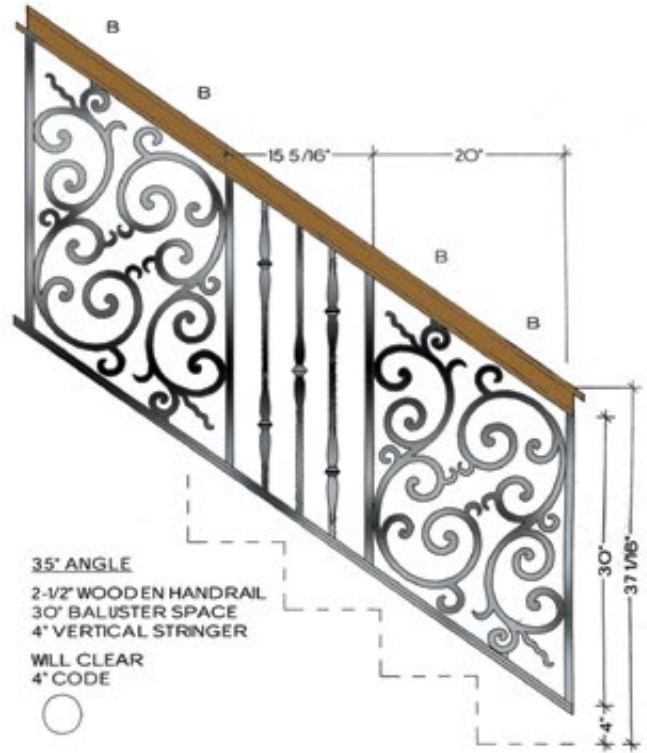
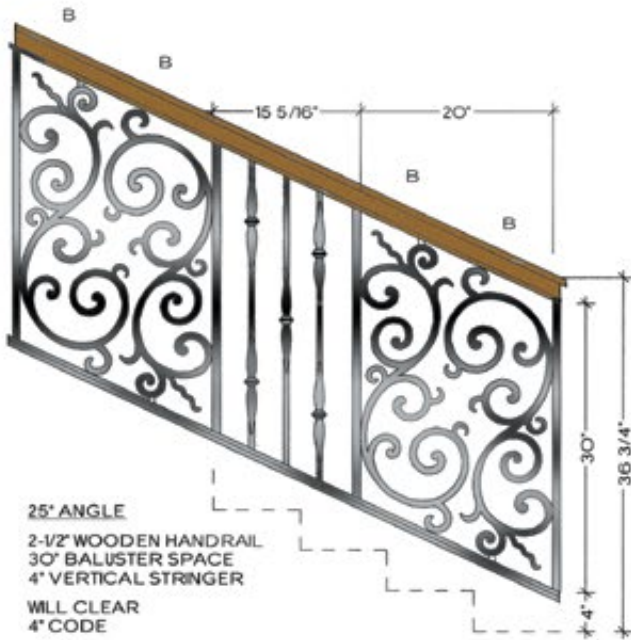

MILANO

PIECE A
FITS LEVEL BALCONY OR LANDING

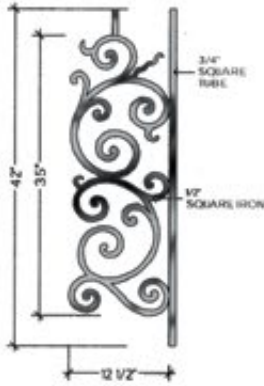

TOP VIEW
A-1
FLAT
HFMO.A1

PIECE B
FITS ALL ANGLES UP TO 48°

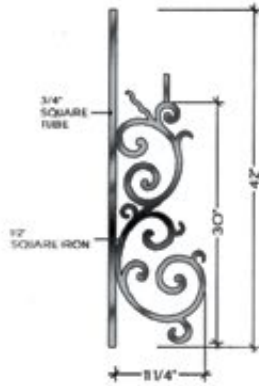

TOP VIEW
B-1
FLAT
HFMO.B1

PIECE B
FITS ALL ANGLES UP TO 48°

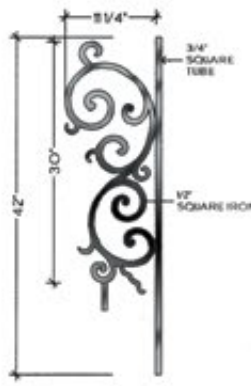

TOP VIEW
B-1
FLAT
HFMO.B1

TERMINATION

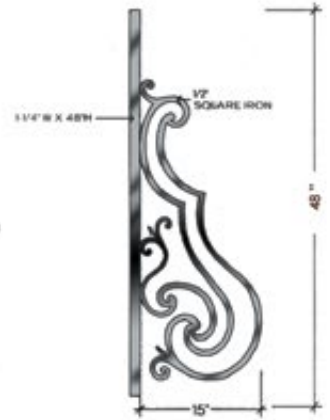

LEFT TERMINATION
RIGHT SIDE VIEW



HFMO.TERM LF

RIGHT TERMINATION
LEFT SIDE VIEW



HFMO.TERM RT

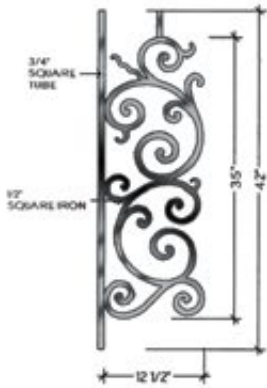

TOP VIEW
A-2
ALL RADII FROM 28" TO 20'-0"
HFMO.A2

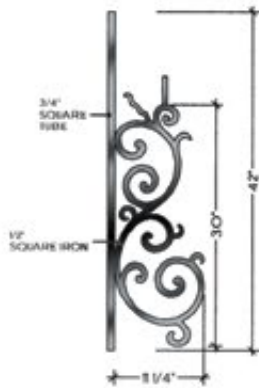

TOP VIEW
B-2
ALL RADII FROM 30" TO 20'-0"
HFMO.B2

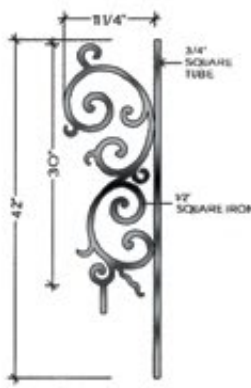

TOP VIEW
B-2
ALL RADII FROM 30" TO 20'-0"
HFMO.B2

RIGHT TERMINATION
LEFT SIDE VIEW

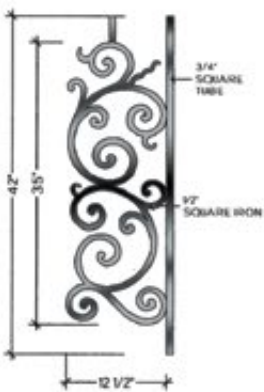

TOP VIEW
A-3
ALL RADII FROM 28" TO 20'-0"
HFMO.A3

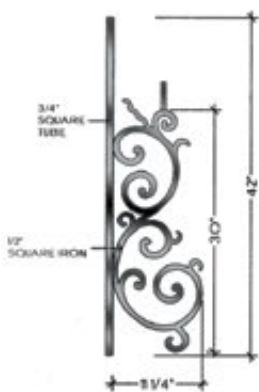

TOP VIEW
B-3
ALL RADII FROM 30" TO 20'-0"
HFMO.B3

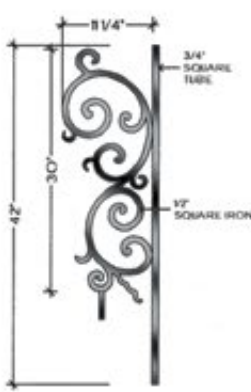

TOP VIEW
B-3
ALL RADII FROM 30" TO 20'-0"
HFMO.B3



BORDEAUX



Bordeaux HFBX.A1 (shown)

3/4" SQUARE
TUBE



5/8" SQUARE
IRON

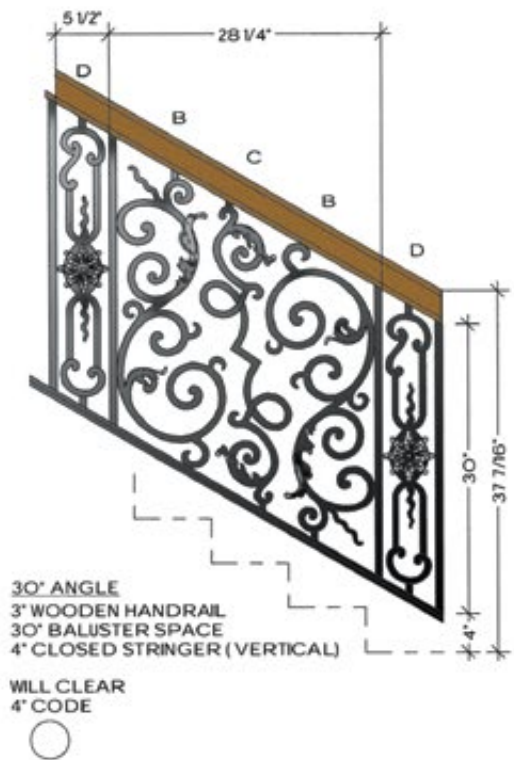
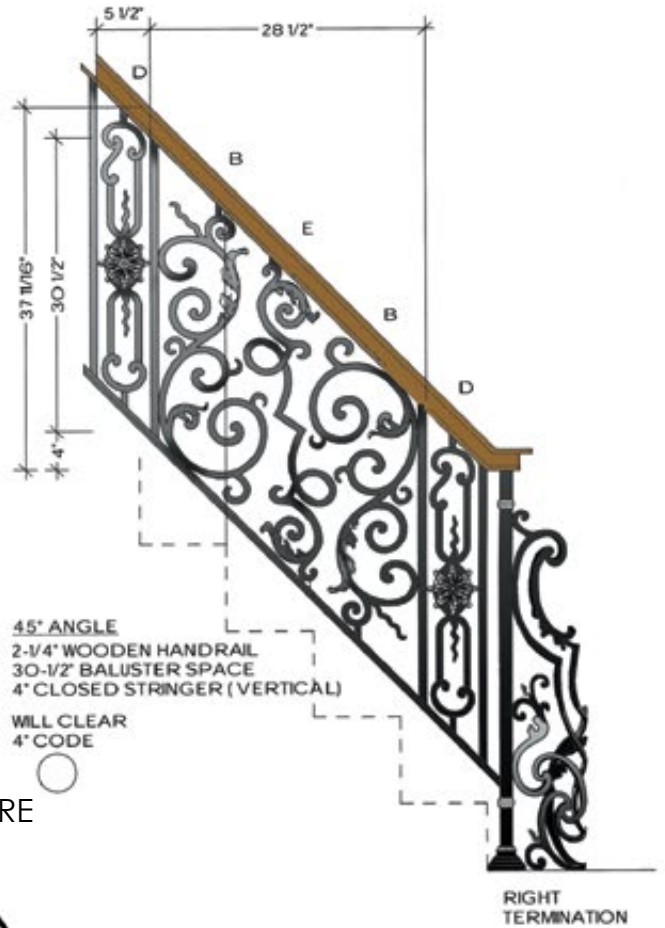

BORDEAUX

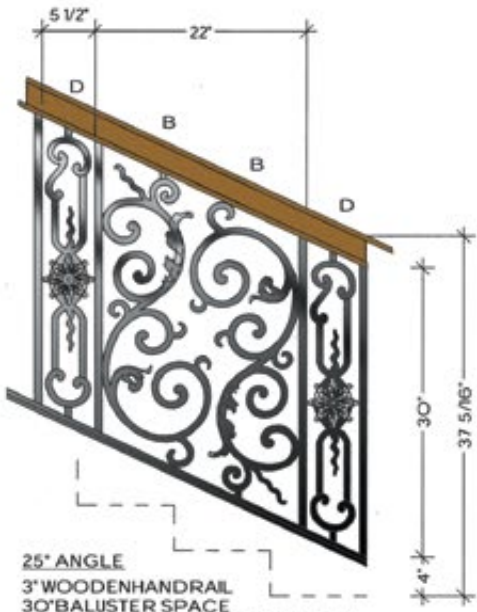

25° ANGLE
 3" WOODEN HANDRAIL
 30" BALUSTER SPACE
 4" CLOSED STRINGER (VERTICAL)

WILL CLEAR
 4" CODE

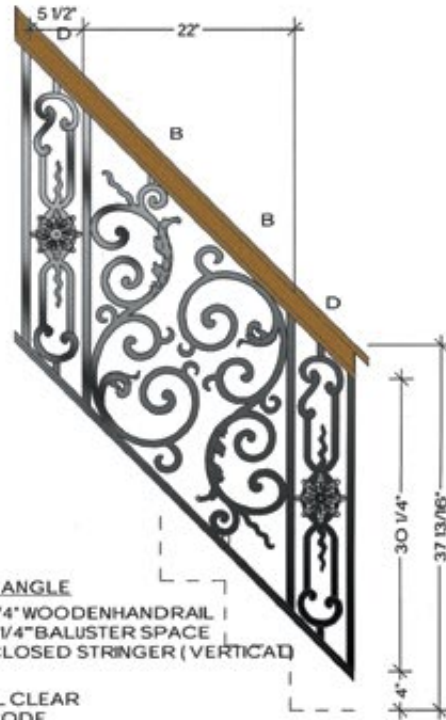

45° ANGLE
 2-3/4" WOODEN HANDRAIL
 30-1/4" BALUSTER SPACE
 4" CLOSED STRINGER (VERTICAL)

WILL CLEAR
 4" CODE

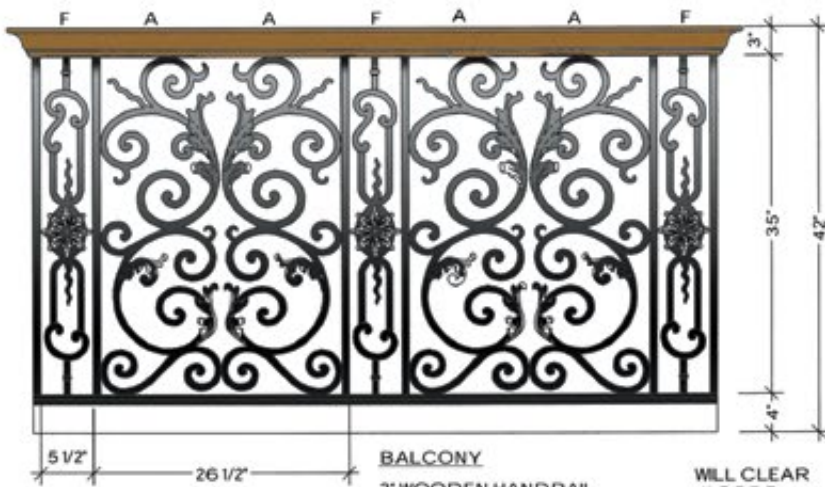

BALCONY
 3" WOODEN HANDRAIL
 35" BALUSTER SPACE
 4" CLOSED STRINGER

WILL CLEAR
 4" CODE



BORDEAUX

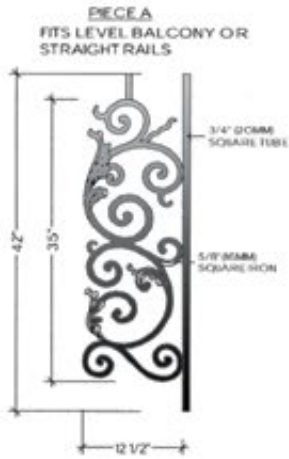

TOP VIEW
A-1 FLAT
HFBX.A1

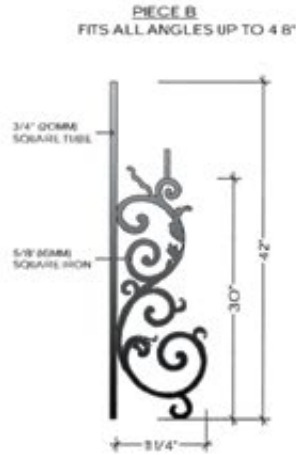

TOP VIEW
B-1 FLAT
HFBX.B1

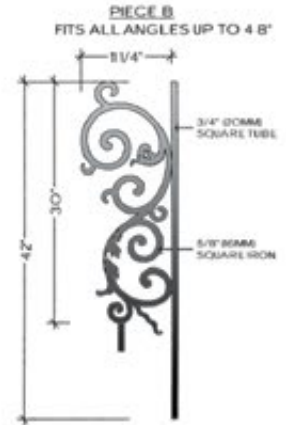

TOP VIEW
B-1 FLAT
HFBX.B1

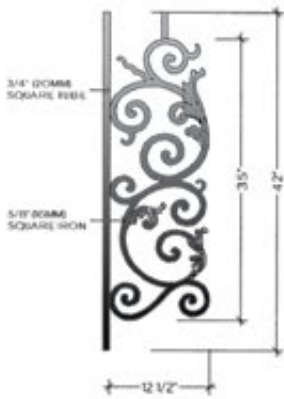

TOP VIEW
A-2
ALL RADIUS FROM 28" TO 20'-0"
HFBX.A2

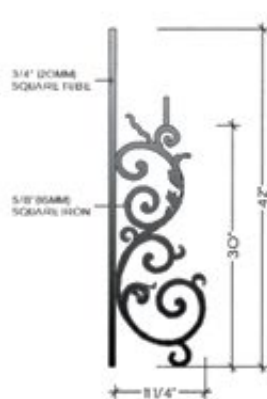

TOP VIEW
B-2
ALL RADIUS FROM 30" TO 20'-0"
HFBX.B2

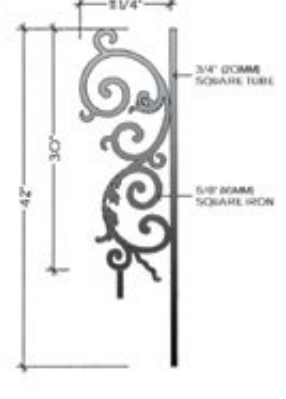

TOP VIEW
B-2
ALL RADIUS FROM 30" TO 20'-0"
HFBX.B2

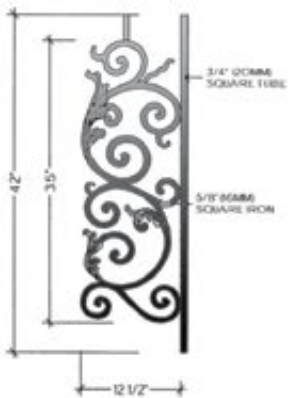

TOP VIEW
A-3
ALL RADIUS FROM 28" TO 20'-0"
HFBX.A3

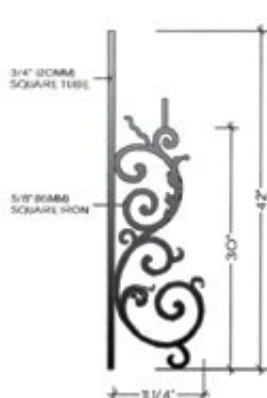

TOP VIEW
B-3
ALL RADIUS FROM 30" TO 20'-0"
HFBX.B3

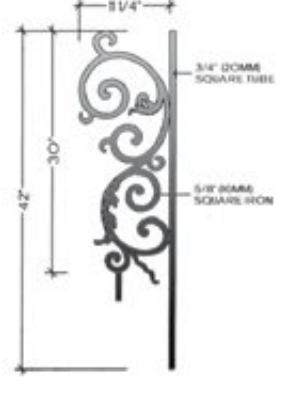

TOP VIEW
B-3
ALL RADIUS FROM 30" TO 20'-0"
HFBX.B3

BORDEAUX

PIECE C
FITS ONLY INCLINE ANGLES BELOW 40°

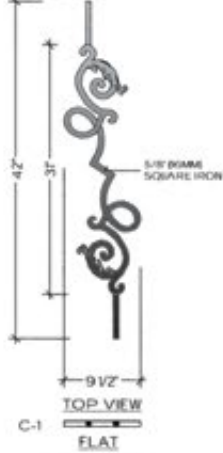

HFBX.C1

PIECE D
FITS ALL ANGLES



HFBX.D

PIECE E
FITS ONLY ANGLES ABOVE 40°

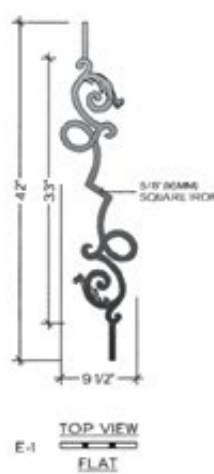

HFBX.E1

RIGHT TERMINATION
INSIDE VIEW

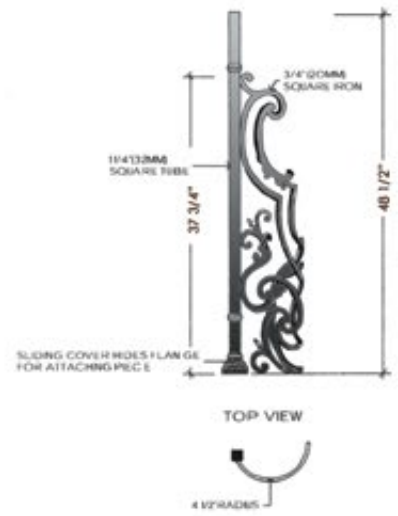

HFBX.TERM RT

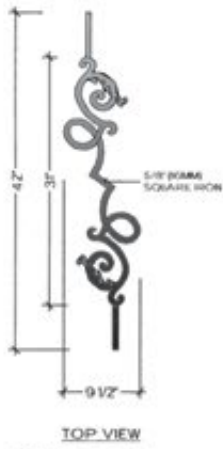

HFBX.C2

ALL RADII FROM 30° TO 20° 0'

PIECE F
FITS LEVEL BALCONY OR STRAIGHT RAIL

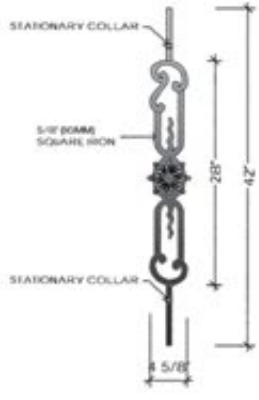

HFBX.F



HFBX.E2

ALL RADII FROM 30° TO 20° 0'

LEFT TERMINATION
INSIDE VIEW

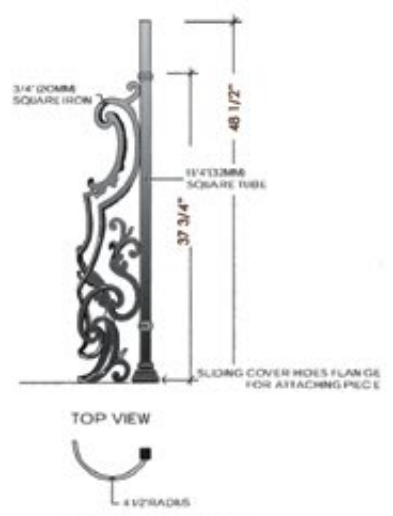

HFBX.TERM LF

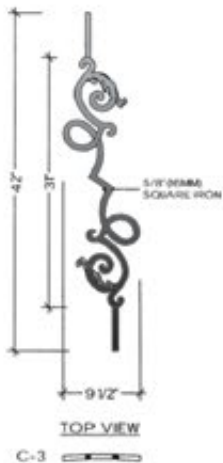

HFBX.C3

ALL RADII FROM 30° TO 20° 0'

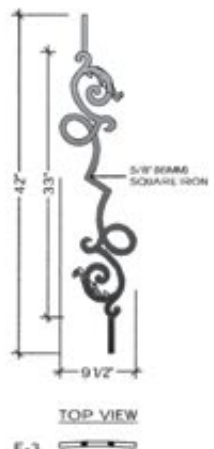

HFBX.E3

ALL RADII FROM 30° TO 20° 0'

REGENCY



Regency HFREA1 (shown)

1" SQUARE
TUBE



3/8" X 1"
FLAT IRON



RIGHT REGENCY
TERMINATION

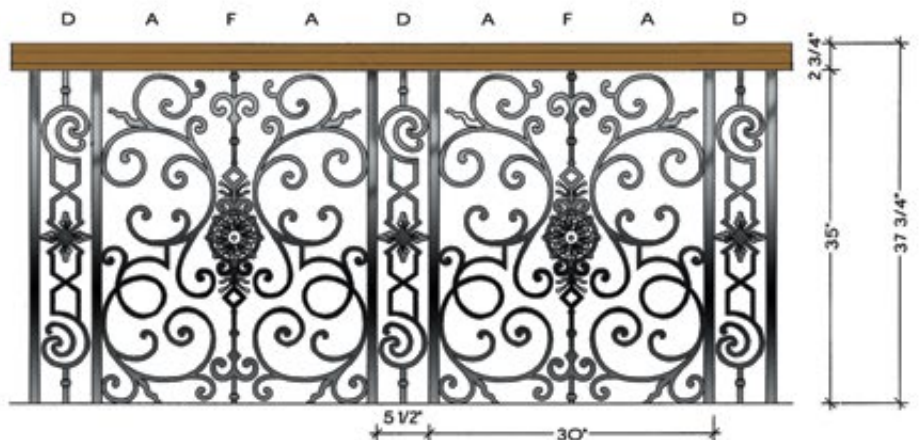
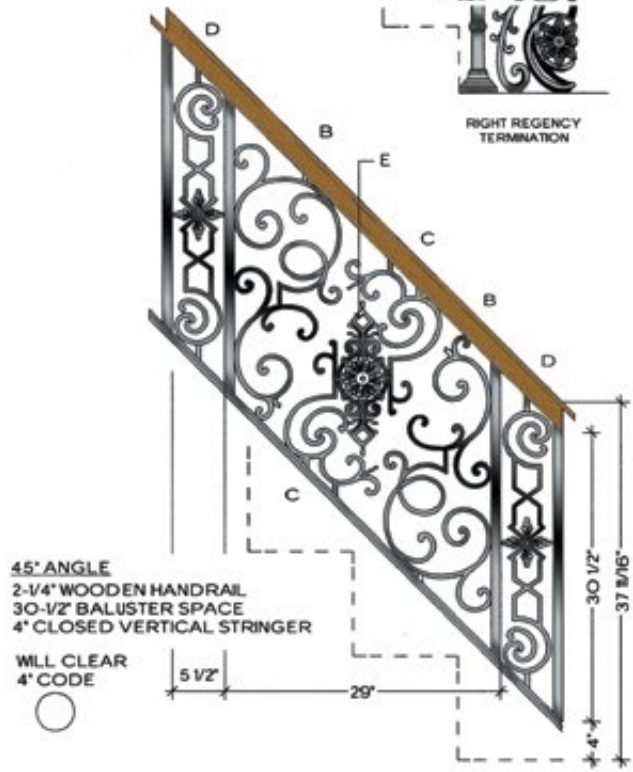

BALCONY

2 3/4" WOODEN HANDRAIL
35" BALUSTER SPACE

WILL CLEAR
4" CODE

REGENCY

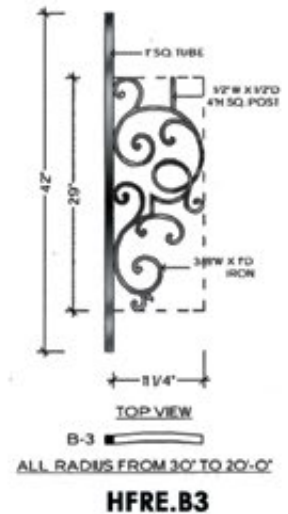
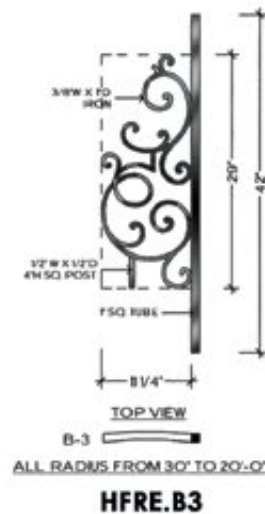
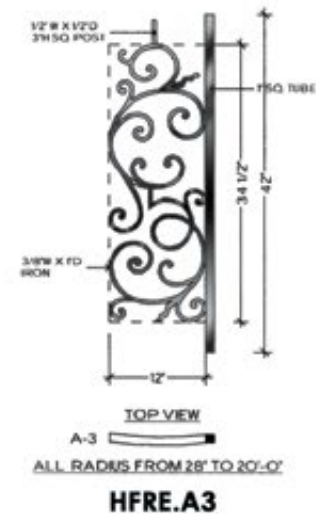
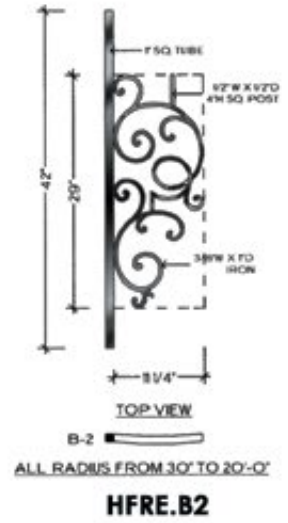
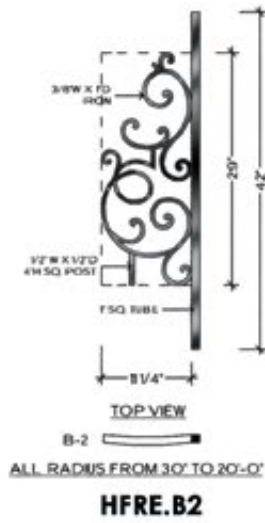
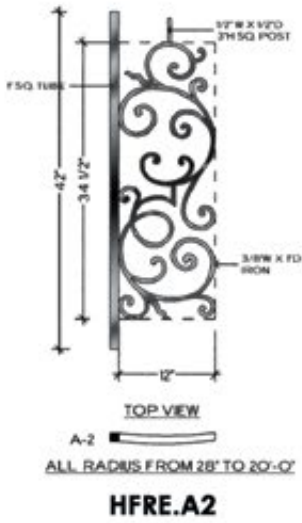
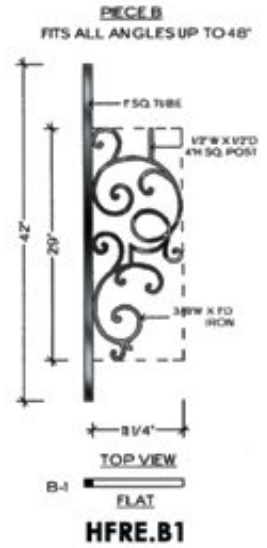
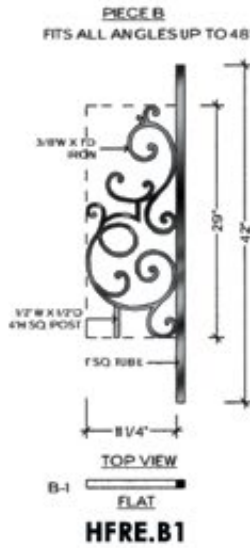

REGENCY

PIECE C
FITS ALL ANGLES UP TO 48°

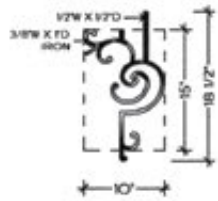

TOP VIEW
FLAT

HFRE.C1

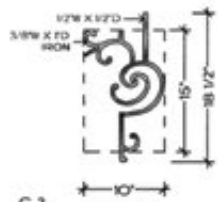

C-2
TOP VIEW
FLAT

ALL RADIUS FROM 30" TO 20'-0"

HFRE.C2

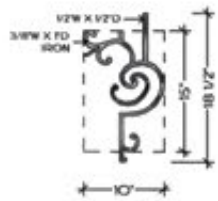

TOP VIEW
C-3

ALL RADIUS FROM 30" TO 20'-0"

HFRE.C3

PIECE C
FITS ALL ANGLES UP TO 48°

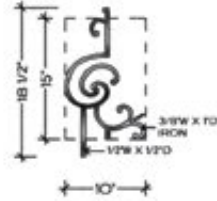

TOP VIEW
C-1

HFRE.C1

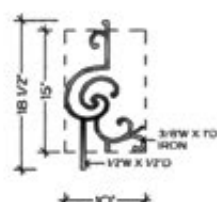

TOP VIEW
C-2

ALL RADIUS FROM 30" TO 20'-0"

HFRE.C2

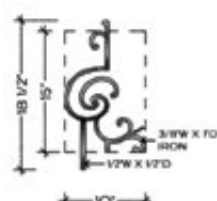

TOP VIEW
C-3

ALL RADIUS FROM 30" TO 20'-0"

HFRE.C3

LEFT SIDE TERMINATION
RIGHT SIDE VIEW

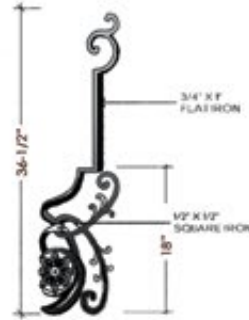

HFRE.TERM LF

RIGHT SIDE TERMINATION
LEFT SIDE VIEW

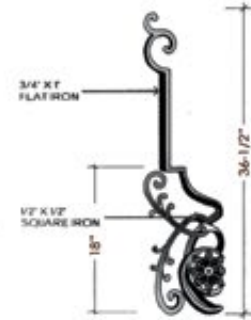

HFRE.TERM RT

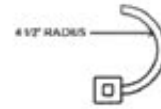
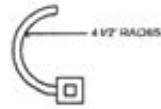

TERMINATION



PIECE D
FITS ALL ANGLES &
LEVEL BALCONY



TOP VIEW
FLAT **HFRE.D**

PIECE E
FITS ALL ANGLES

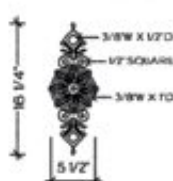

HFRE.E

PIECE F
FITS LEVEL BALCONY
OR STRAIGHT RAIL

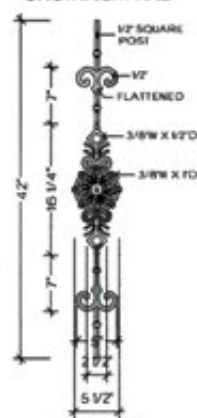

TOP VIEW
FLAT **HFRE.F**



U.S. Pat.
No. 5,827,111
No. 6,059,269

Bordeaux panels (shown)

Regency[©] 71

Wood Products

At House of Forgings we provide much more than just forged iron products, we boast an extensive line of wood components as well.

From handrails to treads, we carry virtually all components necessary to create the staircase or balcony you have envisioned. All products are stocked in Red Oak or Paint Grade, ready for immediate shipping. Components are packaged and shipped with the utmost integrity ensuring that your order will arrive on time and undamaged.

STAIR & RAILING PRODUCTS BY





Elegante-Column newels (RO-4480/RO-4485) paired with Twist/Scroll balusters (shown)

BLANKS



4000
HT. 54"
W = 3-1/4"



4923-41
HT. 41"
W = 1-3/4"
4913-41
HT. 41"
W = 1-1/4"



4005
HT. 54"
W = 3-1/4"



4007
HT. 54"
W = 3-1/4"



Prefinished white
4923-41
HT. 41"
W = 1-3/4"
4913-41
HT. 41"
W = 1-1/4"



Prefinished white
5067-36
HT. 36"
W = 1-1/4"
5067-39
HT. 39"
W = 1-1/4"
5067-41
HT. 41"
W = 1-1/4"

* SPECIAL ORDER IN RED OAK

CLASSIC



5140
HT. 48"
W = 3-1/4"



4140-SP
HT. 48"
W = 3"
STABILIZER
NEWEL



5160
HT. 54"
W = 3-1/4"



5170
HT. 54"
W = 3-1/4"

CLASSIC



Prefinished white
4121-41
HT. 41"
W = 1-1/4"

* SPECIAL ORDER



Prefinished white
4120-41
HT. 41"
W = 1-3/4"



Prefinished white
4220-41
HT. 41"
W = 2-1/4"

* SPECIAL ORDER

All newels stocked in Red Oak (RO), all balusters stocked in prefinished white (PG)

REMINGTON



MAGNOLIA

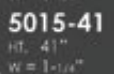

CONCORD



ELEGANTE-COLUMN



4480
HT. 56"
W = 5-1/2"



4485-5
HT. 56"
W = 3-1/4"



4485
HT. 48"
W = 3-1/4"

ELEGANTE-TWIST



4440
HT. 56"
W = 5-1/2"



4450-5
HT. 56"
W = 3-1/4"



4450
HT. 48"
W = 3-1/4"

All Elegante newels and balusters stocked in Red Oak (RO)

BOX NEWELS



Contemporary
Box Newel
4191
HT. 56"
W = 3-1/4"



Contemporary
Stabilizer Newel
4191-SP
HT. 43"
W = 3"



Plain Box
Newel
961-56
HT. 56"
W = 4-1/2"



Recessed Panel
Box Newel
4291
HT. 56"
W = 6"



All box newels come with both square and pyramid tops

BOX NEWELS



Adjustable
Box Newel
4592
HT. 56"
W = 5"
Plain Box
Newel
4691
HT. 56"
W = 6-1/4"



Plain Newel
4592-PLAIN
HT. 56"
W = 3-1/2"



Stabilizer Newel
4592-SP
HT. 43"
W = 3"



Raised Panel
Box Newel
4791
HT. 56"
W = 6-1/4"



Fluted Box
Newel
4891
HT. 56"
W = 6-1/4"



Recessed Panel
Box Newel
4991
HT. 56"
W = 6-1/4"

All box newels stocked in Red Oak (RO)



Elegante-Column newels (RO-4480/RO-4485) paired with Tuscan balusters, Special wedge shaped double end starting step (shown)

HANDRAIL & FITTINGS

6040



6040
Round Wall Rail
Diameter: 1-5/8"

RETURNED END



-  7009
-  7209
-  7709

6010

Colonial Hand Rail
HT. 2-3/8"
W. 2-1/4"



6010 Straight Rail
6010-B Bending Rail
bending rail includes moulding



OPENING CAP



-  7019
-  7219
-  7719

6210

Traditional Hand Rail
HT. 2-3/8"
W. 2-5/8"



6210 Straight Rail
6210-B Bending Rail
bending rail includes moulding



TANDEM CAP



-  7020
-  7220
-  7720

6710

Prestige Hand Rail
HT. 2-3/4"
W. 2-5/8"



6710 Straight Rail
6713 Bending Rail
bending rail includes moulding

OVER EASING



-  7013
-  7213
-  7713

6002

Modern Hand Rail
HT. 1-5/8"
W. 2-3/4"

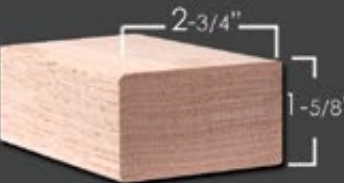

6002 Straight Rail
Available in 8' & 16'
no fittings available

UP EASING 90 DEGREE



-  7012
-  7212
-  7712
-  7014
-  7214
-  7714

6084

Modern Hand Rail
HT. 1-3/4"
W. 2-5/8"



6084 Straight Rail
Available in 8' & 16'
no fittings available



START EASING WITH CAP



-  7010
-  7210
-  7710

All handrail and fittings stocked in Red Oak (RO)

LEVEL QUARTER TURN



	7011
	7211
	7711

LEVEL QUARTER TURN WITH CAP



	7021
	7221
	7721

LEFT & RIGHT HAND S-TURNS



	7022-L
	7222-L
	7022-R
	7222-R

LEFT & RIGHT HAND TURNOUTS



	7040
	7240
	7740
	7045
	7245
	7745

2 RISE STRAIGHT GOOSENECK



	7099
	7299
	7799

LEFT & RIGHT HAND VOLUTES



	7030
	7230
	7730
	7035
	7235
	7735

2 RISE STRAIGHT GOOSENECK WITH CAP



	7088-2
	7288-2
	7788-2

2 RISE LEFT & RIGHT HAND GOOSENECK



	7071
	7271
	7771
	7076
	7276
	7776

2 RISE LEFT & RIGHT HAND GOOSENECK WITH CAP



	7081
	7281
	7781
	7086
	7286
	7786

All handrail and fillings stocked in Red Oak (RO)

TREADS/STEPS/LUMBER/PLY

TREADS

RO-8070

Red Oak Bull Nose Tread
1-1/16" x 11-1/2" x 42, 48, 54,
60, 72, 84, 96"



CLASSIC TREADS

RO-8070-13 x

Red Oak Tread
1-1/16" x 13" x 48, 60, 72, 96"

RO-8070-18 x

Red Oak Tread
1-1/16" x 18" x 48, 60, 72, 84"

RO-8070-20 x 60

Red Oak Tread
1-1/16" x 20" x 60"

RO-8070-20 x 72

Red Oak Tread
1-1/16" x 20" x 72"

RO-8070-24 x

Red Oak Tread
1-1/16" x 24" x 60", 72", 84", 96", 120"

RO-8070-48 x 48

Red Oak Tread
1-1/16" x 48" x 48"

RO-8070-60 x 60

Red Oak Tread
1-1/16" x 60" x 60"

RO-8070-48-MR

1-1/16" x 11-1/2" x 48"

RO-8070-54-MR

1-1/16" x 11-1/2" x 54"

RO-8070-60-MR

1-1/16" x 11-1/2" x 60"

Mitered Return[MR][Reversible]

Overall length does not include mitered return



RETRO TREAD WITH RISER

TREAD

Red Oak Bull Nose Tread with Cove
1 1/16" x 10-1/2" x 42, 54, 60"

RISER

Red Oak Riser
5/8" x 7-1/2" x 42, 54, 60"

RETRO-42 / RETRO-54 / RETRO-60



RETRO RETURN TREAD WITH RISER

TREAD

Red Oak Bull Nose Tread with Cove
1 1/16" x 10-1/2" x 48, 54, 60"

RISER

Red Oak Riser
5/8" x 7-1/2" x 42, 54, 60"

RETRO-42MR / RETRO-54MR / RETRO-60MR



BULL NOSED LANDING TREAD

8090-6

RED OAK

8090-6B

RED OAK BENDING (26 pieces)

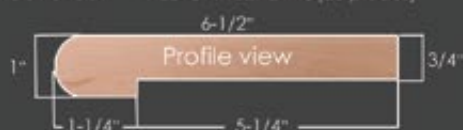

TONGUE & GROOVED BULL NOSED LANDING TREAD

8090-6-G

RED OAK (grooved)



TONGUE & GROOVED LUMBER

8095-8-T&G

RED OAK (tongue & grooved)

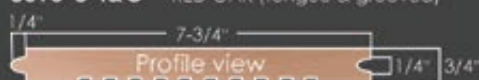

8095-12-T&G

RED OAK (tongue & grooved)

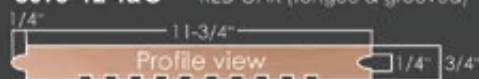

1" BULL NOSING

8080

RED OAK

8080-B

RED OAK BENDING
(5 pieces)





DOUBLE END STARTING STEP

Diameter: 13-3/4"
8015-48 (48" throat) (72" overall)
8015-54 (54" throat) (78" overall)
8015-60 (60" throat) (84" overall)
 Red Oak(RO)

STARTER STEP VENEER

Width: 8"
 Length: 120"
RO-VENEER (Red Oak)

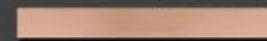

SINGLE END STARTING STEP

Diameter: 13-3/4"
8010-48 (48" throat) (60" overall)
8010-60 (60" throat) (72" overall)
8010-72 (72" throat) (84" overall)
 Red Oak(RO)



SPECIAL WEDGE SHAPED DOUBLE END STARTING STEP

Diameter: 12-3/4" (small end)
 Diameter: 18-1/2" (large end)
RO-8915-48 (48" throat) (73-1/2" overall)
RO-8915-54 (54" throat) (79-1/2" overall)
 (Reversible)
 Red Oak(RO)



FALSE END STARTING STEP

Diameter: 13-3/4" Diameter: 17-1/2"
 Length: 17-5/8" overall Length: 21-3/4" overall
8011 **8012**
 Red Oak(RO)

LUMBER

RO-06 Red Oak 3/4" x 5-1/2" S4S Lumber
RO-08 Red Oak 3/4" x 7-1/4" S4S Lumber
RO-08-B Red Oak 3/4" x 7-1/4" Bending [29 pieces]
RO-12 Red Oak 3/4" x 11-1/4" S4S Lumber

MDF-06 MDF 11/16" x 5-1/4"
MDF-08 MDF 11/16" x 7-1/4"
MDF-12 MDF 11/16" x 11-1/4"

PLYWOOD

PLY-1/4-MDF MDF 1/4" x 4' x 8' **Half Sheet** 1/4" x 2' x 8'
PLY-3/4-MDF MDF 3/4" x 4' x 8'
PLY-1/8-RO Red Oak 1/8" x 4' x 8' **Half Sheet** 1/4" x 2' x 8'
PLY-1/4-RO Red Oak 1/4" x 4' x 8' **Half Sheet** 1/4" x 2' x 8'
PLY-1/2-RO Red Oak 1/2" x 4' x 8'
PLY-3/4-RO Red Oak 3/4" x 4' x 8'
PLY-1/8-Birch Birch 1/8" x 4' x 8'
PLY-1/4-Birch Birch 1/4" x 4' x 8' **Half Sheet** 1/4" x 2' x 8'
PLY-1/2-Birch Birch 1/2" x 4' x 8'
PLY-3/4-Birch Birch 3/4" x 4' x 8'
PLY-3/8-Bending Red Oak 3/8" x 4' x 8' (bending board)

WOOD MOULDING & FLEXIBLE TRIM



RO-C8	Red Oak 2-1/2" x 11/16" Colonial Casing
PG-C8	Paint Grade 2-1/2" x 11/16" Colonial Casing
FLEX-C8	Paint Grade 2-1/2" x 11/16" Colonial Casing



RO-CAP MOULD	Red Oak 1-1/8" x 3/8" Cap Mould
PG-CAP MOULD	Paint Grade 1-1/8" x 3/8" Cap Mould



RO-6007	Red Oak 1-3/4" Flet
PG-6007	Paint Grade 1-3/4" Flet



RO-6050	Red Oak 1-1/4" Flet
PG-6050	Paint Grade 1-1/4" Flet



RO-PM-1	Red Oak 11/16" x 1/-1/4" RAB, Panel Mould
PG-PM-1	Paint Grade 11/16" x 1/-1/4" RAB, Panel Mould
Flex-PM-1	Flexible Smooth 11/16" x 1/-1/4" RAB, Panel Mould
Flex-PM-1-WG	Flexible Wood Grain 11/16" x 1/-1/4" RAB, Panel Mould (1/4" Offset)



RO-PM-2	Red Oak 11/16" x 1/-1/4" RAB, Panel Mould
PG-PM-2	Paint Grade 11/16" x 1/-1/4" RAB, Panel Mould
Flex-PM-2	Flexible Smooth 11/16" x 1/-1/4" RAB, Panel Mould
Flex-PM-2-WG	Flexible Wood Grain 11/16" x 1/-1/4" RAB, Panel Mould (3/4" Offset)



RO-PM-5	Red Oak 11/16" x 1-1/8" Flat Panel Mould
PG-PM-5	Paint Grade 11/16" x 1-1/8" Flat Panel Mould
Flex-PM-5	Flexible Smooth 11/16" x 1-1/8" Flat Panel Mould
Flex-PM-5-WG	Flexible Wood Grain 11/16" x 1-1/8" Flat Panel Mould



RO-8050	Red Oak 7/16" x 3/4" Base Shoe Mould
Flex-MS-127	Flexible Smooth 7/16" x 3/4" Base Shoe Mould
Flex-MS-127-WG	Flexible Wood Grain 7/16" x 3/4" Base Shoe Mould



RO-8060	Red Oak 3/4" x 3/4" Cove Mould
PG-8060	Paint Grade 3/4" x 3/4" Cove Mould
Flex-MS-92	Flexible Smooth 3/4" x 3/4" Cove Mould
Flex-MS-92-WG	Flexible Wood Grain 3/4" x 3/4" Cove Mould



RO-8065	Red Oak 1/2" x 1/2" Cove Mould
PG-8065	Paint Grade 1/2" x 1/2" Cove Mould
Flex-MS-101	Flexible Smooth 1/2" x 1/2" Cove Mould
Flex-MS-101-WG	Flexible Wood Grain 1/2" x 1/2" Cove Mould



Flex-LS-105	Flexible Smooth 3/4" x 3/4" Quarter Round Mould
Flex-LS-105-WG	Flexible Wood Grain 3/4" x 3/4" Quarter Round Mould

ACCESSORIES

WALL RAIL BRACKET

1-1/4" x 2-3/8" Mounting Plate
3" Extension From Wall



- HFBC.3002 (BRUSHED CHROME)
- HFCV.3002 (COPPER VEIN)
- HFORB.3002 (OIL RUBBED BRONZE)
- HFORC.3002 (OIL RUBBED COPPER)
- HFSC.3002 (SATIN CLEAR)
- HFSP.3002 (SILVER VEIN)
- HFSTB.3002 (SATIN BLACK)

HANDRAIL BRACKET

2-1/6" Rd. Mounting Plate
3" Extension From Wall



- HFBC.3003 (BRUSHED CHROME)
- HFAN.3003 (ANTIQUE NICKEL)
- HFCE.3003 (CHROME)
- HFNL.3003 (NICKEL)
- HFCV.3003 (COPPER VEIN)
- HFORB.3003 (OIL RUBBED BRONZE)
- HFORC.3003 (OIL RUBBED COPPER)
- HFPB.3003 (POLISHED BRASS)
- HFSC.3003 (SATIN CLEAR)
- HFSP.3003 (SILVER VEIN)
- HFSTB.3003 (SATIN BLACK)
- HFVB.3003 (VINTAGE BRASS)

WOOD GLUE & FILLER



- S-9202 (1 Gal.)
- S-9203 (32 oz.)
- S-9204 (16 oz.)

FAM-O-WOOD
RO-9208 (Red Oak)

EPOXY GUN-EPC-112



EPOXY-EPC-410



EPOXY PASTE EPC-7



OAK ROSETTES



- RO-7033 4" x 5-1/2" (Red Oak)
- RO-7037 4" x 5-1/2" (Red Oak)
- RO-7039 4" x 4" (Red Oak)

OAK PLUGS

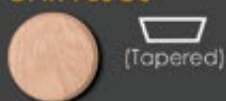

- RO-9001 (3/8")
- RO-9002 (1/2")
- RO-9003 (5/8")
- RO-9004 (3/4")
- RO-9005 (1")
- RO-9006 (1-1/4")
- RO-9007 (1-1/2")

NEWEL FASTENER

S-9403



Sure Tite

NEWEL FASTENER

S-9401



Key Lock

NEWEL CAP

SQUARE CAP-4000

3-1/4" Square
3/4" x 1" dowel



RAIL BOLT KIT

S-9600

(Includes hex nut, spacer
and 1" Red Oak plug)



RAIL BOLT DRIVER

S-9600-D

(fits machine thread)



sold individually

DOWEL SCREW

C-905-2 (25 per bag)



DRIVER

C-905-2D

(fits wood screw thread)



sold individually



Maple



Poplar



White Oak



Red Oak (RO)



Prefinished White (PG)

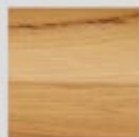

Hickory/Pecan



Clear Alder



American Cherry



Walnut



Sapele Mahogany



Brazilian Cherry

Wood Products

All wood products are stocked in Red Oak(RO) or Prefinished White(PG) unless otherwise noted.

Domestic and Exotic Wood Species

All wood products in non-stock species are available by special order.



Custom Fabrication & Powdercoating

We specialize in modifying our standard iron components to suit the needs of your specific project. Whether your project involves balusters to be extended, panels modified to ensure code compliance or matching one of our powdercoated finishes or patinas we can help.



Marketing Literature

We offer a wide array of marketing literature designed to support product sales: product catalogs, brochures, flyers, postcards and customized literature are available through our authorized dealer program.



Sales Displays & Product Samples

Our wide variety of sales displays will provide you with the tools to sell products. We have sizes to fit your floor space. Custom displays are also available.



Software & Design

Stair Artist stair design tool makes it easy to plan your staircase project. Our extensive library of CAD images and product photos will aid and inspire you in designing your staircase.

16684 Air Center Blvd.
Houston, Texas 77032
Toll Free 866.443.4848 Fax 281.443.1133
www.houseofforgings.net

Please contact us for more detailed information
or for a listing of distributors near you.

STAIR & RAILING PRODUCTS BY

